

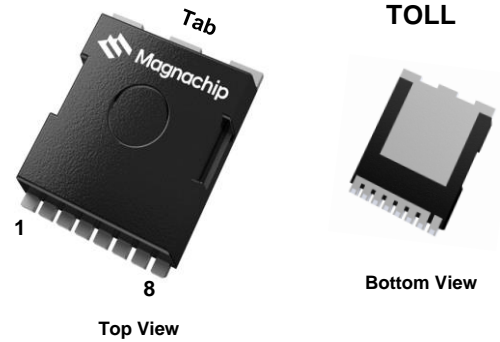


# MDT15N054PTRH

Single N-channel Trench MOSFET 150V 5.4m $\Omega$  191A

## FEATURES

- Trench power MOSFET technology
- N-channel, normal level
- Enhanced avalanche ruggedness
- 100% Avalanche tested
- Maximum 175°C junction temperature

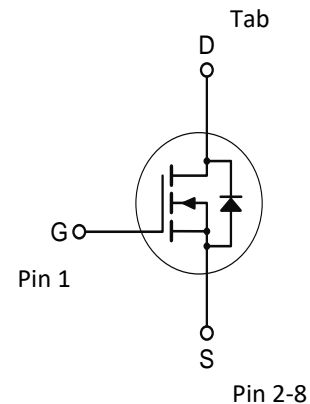


## APPLICATIONS

- DC/DC and AC/DC converters
- Brushed and BLDC Motor drive systems
- Load switch

## KEY PERFORMANCE PARAMETERS

$V_{DS}$	150	V
$R_{DS(on), typ.}$	0.00463	$\Omega$
$I_D$	191	A
$Q_G, typ.$	90	nC
Junction temperature, max.	175	$^{\circ}C$



## ORDERING INFORMATION

Type / Ordering Code	Package	Marking	Packing	RoHS Status
MDT15N054PTRH	TOLL	MDT15N054	Tape & Reel	Halogen Free

<http://www.magnachip.com/>

**ABSOLUTE MAXIMUM RATINGS**, at  $T_C = 25^\circ\text{C}$ , unless otherwise specified

PARAMETER		SYMBOL	RATING	UNIT
Drain-source Voltage		$V_{DS}$	150	V
Gate-source Voltage		$V_{GS}$	$\pm 20$	V
Drain current	$T_C=25^\circ\text{C}$	$I_D$	191	A
	$T_C=100^\circ\text{C}$		135	A
<sup>1)</sup> Pulsed drain current	$T_C=25^\circ\text{C}$	$I_{DM}$	765	A
Total power dissipation	$T_C=25^\circ\text{C}$	$P_{tot}$	517	W
	$T_C=100^\circ\text{C}$		259	W
<sup>2)</sup> Avalanche energy, single pulse		$E_{AS}$	392	mJ
Operating and storage temperature		$T_j, T_{stg}$	- 55 ~ 175	$^\circ\text{C}$

**THERMAL CHARACTERISTICS**

PARAMETER	SYMBOL	RATING	UNIT
Thermal resistance, junction - case	$R_{\theta JC}$	0.29	$^\circ\text{C}/\text{W}$
<sup>3)</sup> Thermal resistance, junction - ambient	$R_{\theta JA}$	40	$^\circ\text{C}/\text{W}$

**Notes**

- Pulse width limited by  $T_{jmax}$
- Starting  $T_J=25^\circ\text{C}$ ,  $L=1\text{mH}$ ,  $I_{AS}=28\text{A}$ ,  $V_{DD}=50\text{V}$ ,  $V_{GS}=10\text{V}$
- Surface mounted FR-4 board by JEDEC (jesd51-7)

**ELECTRICAL CHARACTERISTICS (T<sub>J</sub> = 25°C)****STATIC CHARACTERISTICS**

PARAMETER	Symbol	Min.	Typ.	Max.	Unit	Conditions / Note
Drain-source breakdown voltage	V <sub>(BR)DSS</sub>	150	-	-	V	V <sub>GS</sub> =0 V, I <sub>D</sub> =250 μA
Gate threshold voltage	V <sub>GS(th)</sub>	2.40	3.10	3.90	V	V <sub>DS</sub> =V <sub>GS</sub> , I <sub>D</sub> =250 μA
Zero gate voltage drain current	I <sub>DSS</sub>	-	-	1	μA	V <sub>DS</sub> =150 V, V <sub>GS</sub> =0 V
Gate-source leakage current	I <sub>GSS</sub>	-	-	± 100	nA	V <sub>GS</sub> =±20 V, V <sub>DS</sub> =0 V
Drain-source on-state resistance	R <sub>DS(on)</sub>	-	4.63	5.40	mΩ	V <sub>GS</sub> =10 V, I <sub>D</sub> =70 A
Gate resistance	R <sub>G</sub>	-	2.30	-	Ω	f=1MHz
Transconductance	g <sub>fs</sub>	-	120	-	S	V <sub>DS</sub> =20 V, I <sub>D</sub> =70 A

**DYNAMIC CHARACTERISTICS**

PARAMETER	Symbol	Min.	Typ.	Max.	Unit	Conditions / Note
Input capacitance	C <sub>iss</sub>	-	6418	-	pF	V <sub>DS</sub> =0 V, V <sub>GS</sub> =75 V, f=1 MHz
Output capacitance	C <sub>oss</sub>	-	688	-	pF	V <sub>GS</sub> =0 V, V <sub>DS</sub> =75 V, f=1 MHz
Reverse transfer capacitance	C <sub>rss</sub>	-	15	-	pF	V <sub>GS</sub> =0 V, V <sub>DS</sub> =75 V, f=1 MHz
Turn-on delay time	t <sub>d(on)</sub>	-	31	-	ns	V <sub>DD</sub> =75 V, V <sub>GS</sub> =10 V, I <sub>D</sub> =70 A, R <sub>G,ext</sub> =3Ω
Rise time	t <sub>r</sub>	-	13	-	ns	V <sub>DD</sub> =75 V, V <sub>GS</sub> =10 V, I <sub>D</sub> =70 A, R <sub>G,ext</sub> =3Ω
Turn-off delay time	t <sub>d(off)</sub>	-	80	-	ns	V <sub>DD</sub> =75 V, V <sub>GS</sub> =10 V, I <sub>D</sub> =70 A, R <sub>G,ext</sub> =3Ω
Fall time	t <sub>f</sub>	-	17	-	ns	V <sub>DD</sub> =75 V, V <sub>GS</sub> =10 V, I <sub>D</sub> =70 A, R <sub>G,ext</sub> =3Ω

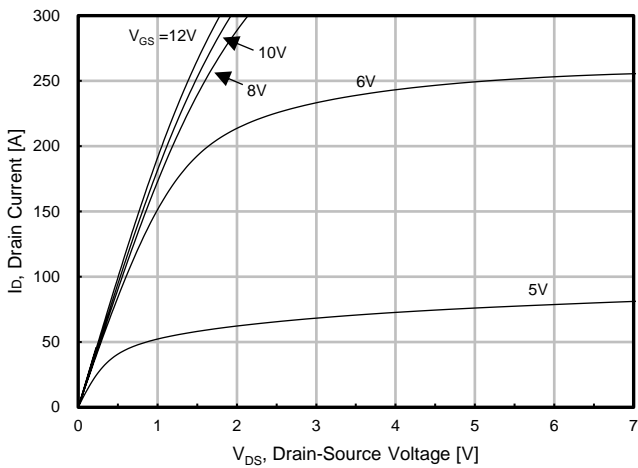
**GATE CHARGE CHARACTERISTICS**

PARAMETER	Symbol	Min.	Typ.	Max.	Unit	Conditions / Note
Gate to source charge	Q <sub>gs</sub>	-	31	-	nC	V <sub>DD</sub> =75 V, I <sub>D</sub> =70 A, V <sub>GS</sub> =0 to 10 V
Gate charge at threshold	Q <sub>gs(th)</sub>	-	18	-	nC	V <sub>DD</sub> =75 V, I <sub>D</sub> =70 A, V <sub>GS</sub> =0 to 10 V
Gate to drain charge	Q <sub>gd</sub>	-	20	-	nC	V <sub>DD</sub> =75 V, I <sub>D</sub> =70 A, V <sub>GS</sub> =0 to 10 V
Switching charge	Q <sub>sw</sub>	-	33	-	nC	V <sub>DD</sub> =75 V, I <sub>D</sub> =70 A, V <sub>GS</sub> =0 to 10 V
Gate charge total	Q <sub>g</sub>	-	90	-	nC	V <sub>DD</sub> =75 V, I <sub>D</sub> =70 A, V <sub>GS</sub> =0 to 10 V
Gate plateau voltage	V <sub>plateau</sub>	-	5.3	-	V	V <sub>DD</sub> =75 V, I <sub>D</sub> =70 A, V <sub>GS</sub> =0 to 10 V

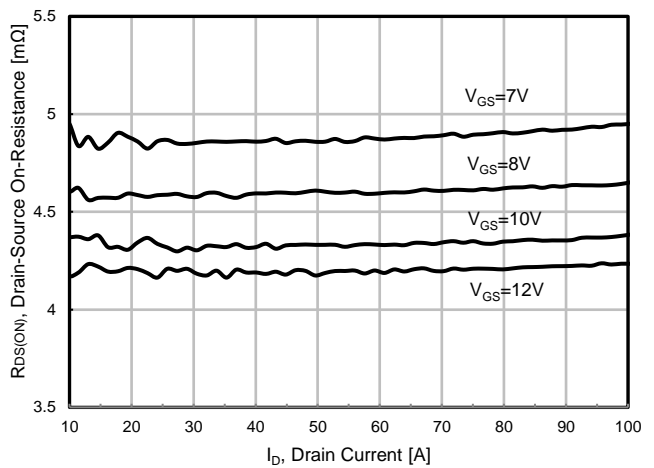
**SOURCE-DRAIN DIODE**

PARAMETER	Symbol	Min.	Typ.	Max.	Unit	Conditions / Note
Diode continuous forward current	I <sub>S</sub>	-	-	167	A	-
Diode pulse current	I <sub>S,pulse</sub>	-	-	668	A	pulsed; t <sub>p</sub> ≤ 10 μs
Diode forward voltage	V <sub>SD</sub>	-	0.8	1.2	V	V <sub>GS</sub> =0 V, I <sub>F</sub> =70 A
Reverse recovery time	t <sub>rr</sub>	-	113	-	ns	I <sub>F</sub> =70 A, d <sub>I</sub> /dt=100 A/μs
Reverse recovery charge	Q <sub>rr</sub>	-	684	-	nC	I <sub>F</sub> =70 A, d <sub>I</sub> /dt=100 A/μs

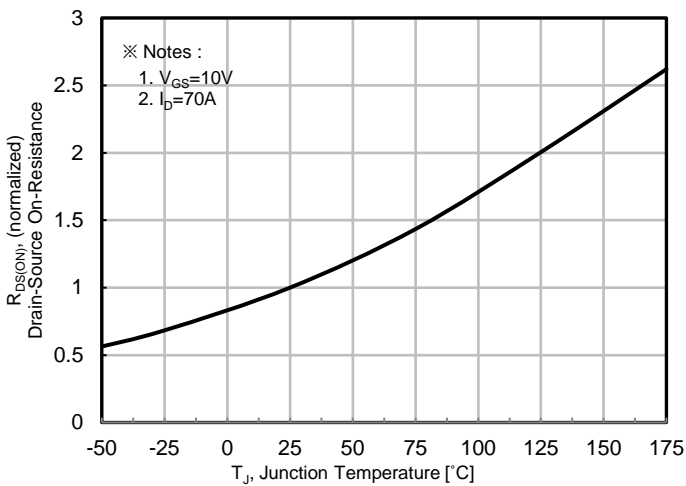
**Electrical characteristics diagrams (25 °C, unless otherwise noted)**



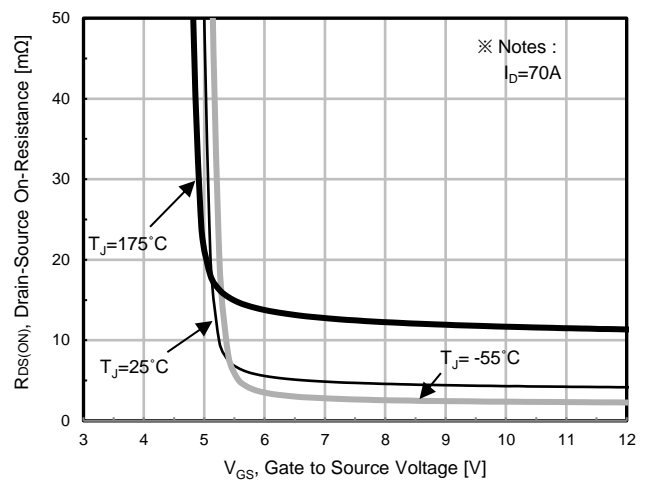
**Fig. 1. Output Characteristics (25°C)**



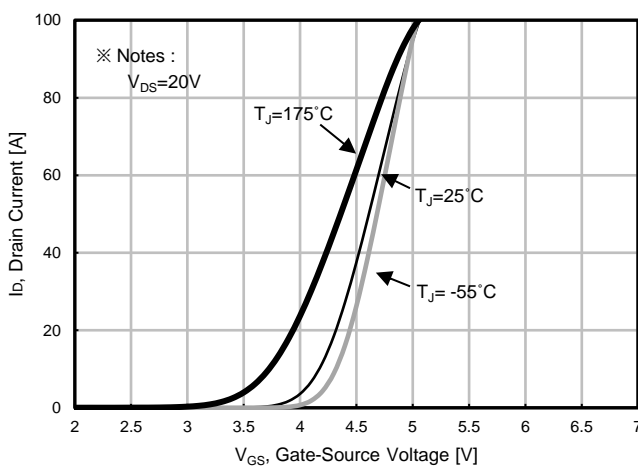
**Fig. 2. Static On-Resistance Variation**



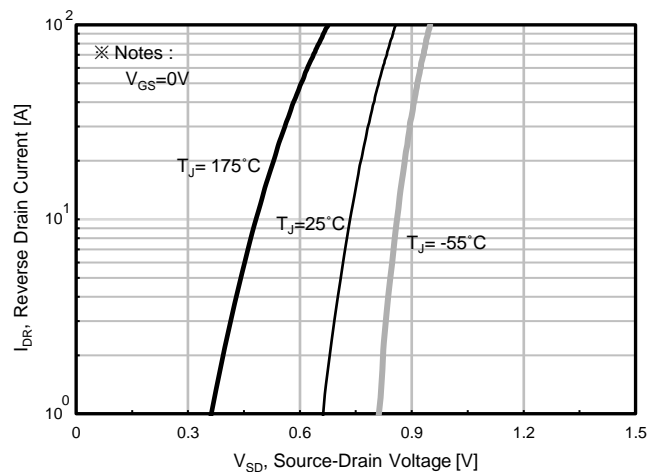
**Fig. 3. On-Resistance vs. Junction Temperature**



**Fig. 4. On-Resistance vs. Gate to source Voltage**

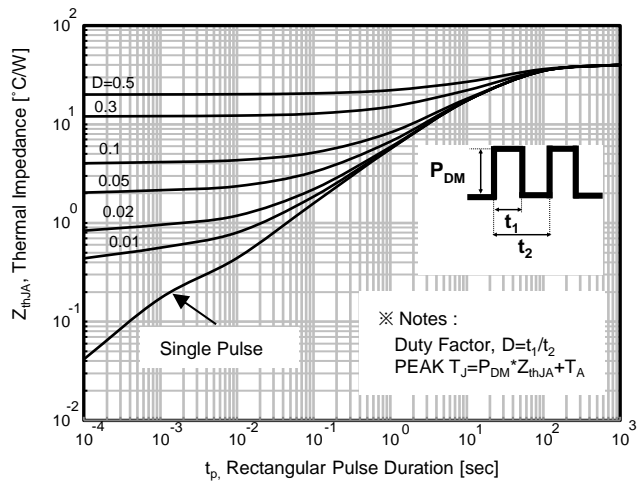
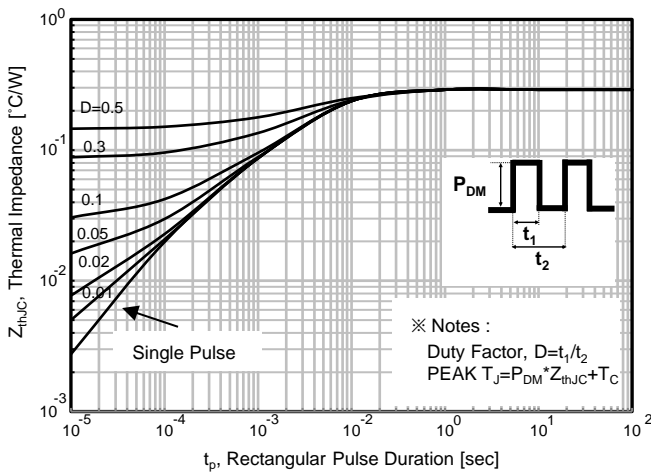
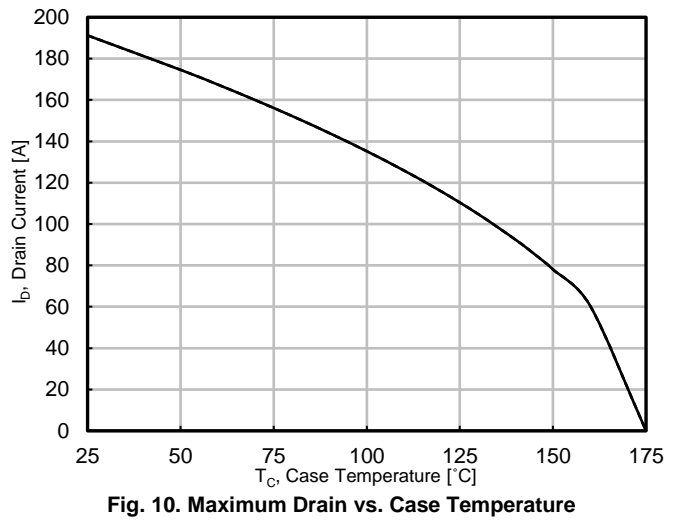
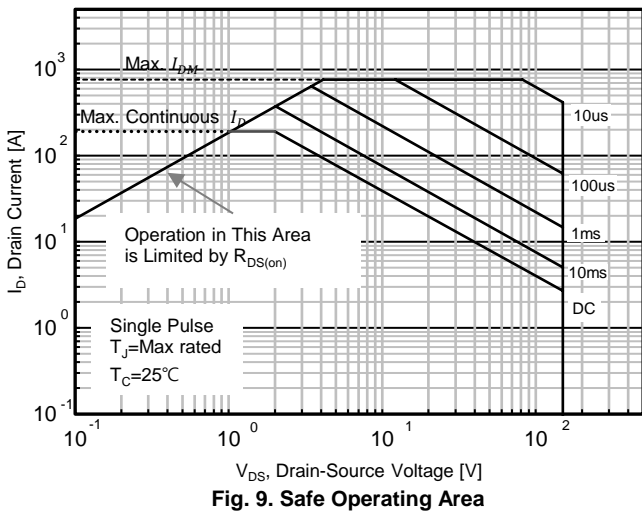
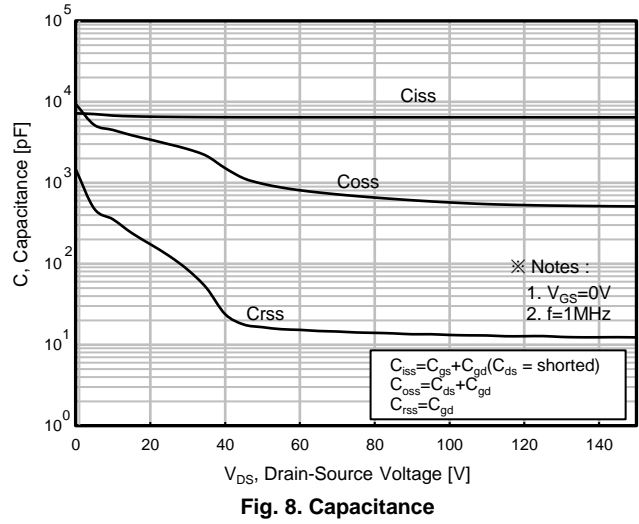
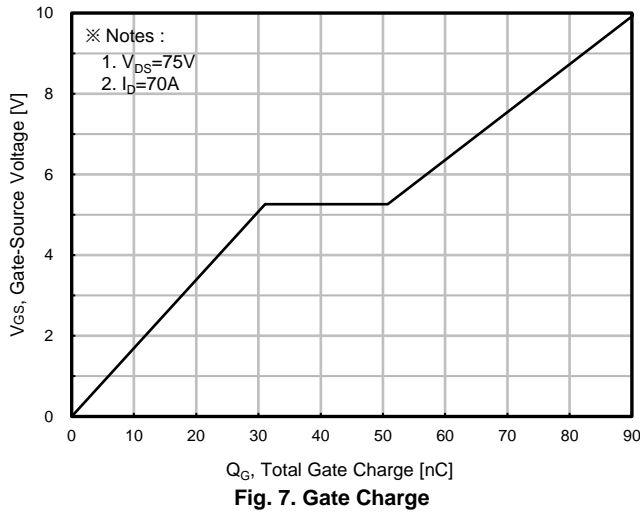


**Fig. 5. Transfer Characteristics**



**Fig. 6. Body Diode Forward Voltage Variation with Source Current and Temperature**

Electrical characteristics diagrams (25 °C, unless otherwise noted)



## Electrical characteristics diagrams (25 °C, unless otherwise noted)

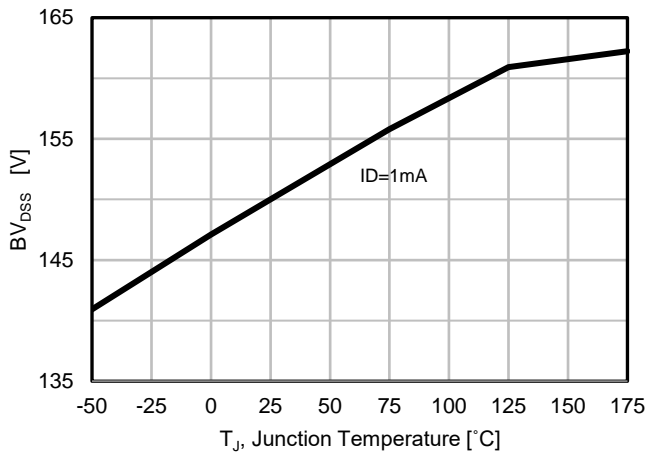
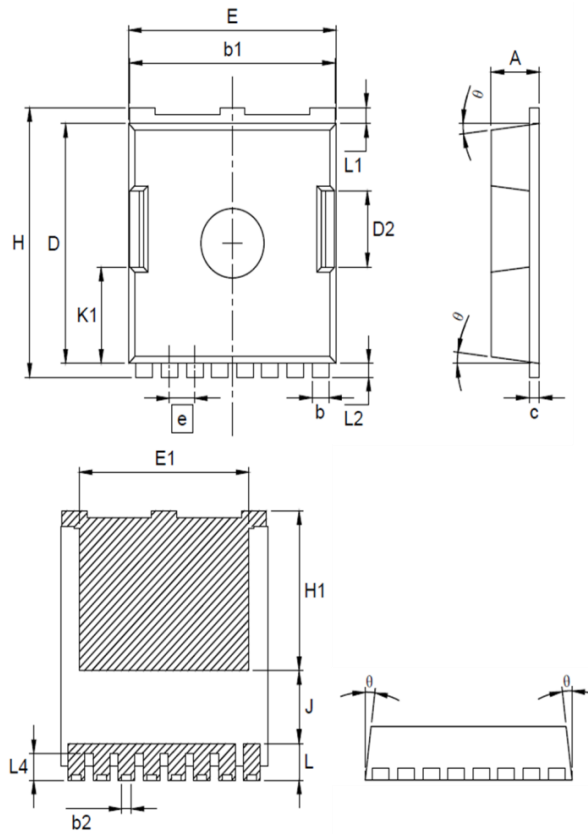


Fig.13 Drain-Source Voltage vs. Temperature

# Package information

## TOLL




Symbol	Dimension (mm)		
	Min	Nom	Max
A	2.20	-	2.40
b	0.70	-	0.90
b1	9.70	-	9.90
b2	0.37	-	0.50
c	0.40	-	0.60
D	10.28	-	10.58
D2	3.10	-	3.65
E	9.70	9.90	10.10
E1	7.70	8.00	8.30
e	BSC 1.20		
H	11.48	11.68	11.90
H1	6.75	-	7.15
J	2.80	-	3.30
K1	3.98	4.18	4.38
L	1.38	1.60	1.98
L1	0.60	0.70	0.80
L2	0.50	0.60	0.70
L4	1.00	1.15	1.30
Θ	4°	7°	10°

### Notes

Package body size, length and width do not include mold flash, protrusions and gate burrs.

**DISCLAIMER :**

The Products are not designed for use in hostile environments, including, without limitation, aircraft, nuclear power generation, medical appliances, and devices or systems in which malfunction of any Product can reasonably be expected to result in a personal injury. Seller's customers using or selling Seller's products for use in such applications do so at their own risk and agree to fully defend and indemnify Seller.

Magnachip reserves the right to change the specifications and circuitry without notice at any time. Magnachip does not consider responsibility for use of any circuitry other than circuitry entirely included in a Magnachip product.  Magnachip are registered trademarks of Magnachip Semiconductor Ltd.