

MMF60R360RZ

600V 0.36Ω N-channel MOSFET

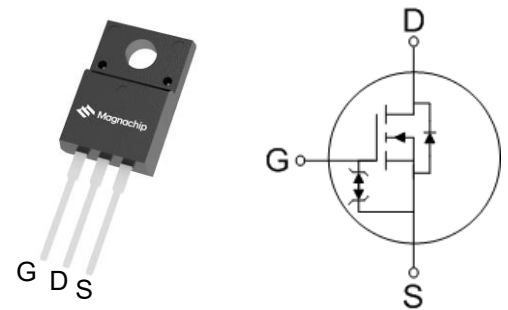
■ Description

MMF60R360RZ is power MOSFET using Magnachip's advanced super junction technology that can realize very low on-resistance and gate charge. This device combines improvement of switching speed with effective switching behavior. And it also will provide much high efficiency by using optimized charge coupling technology. These user friendly devices give an advantage of Low EMI to designers as well as low switching loss.

■ Key Parameters

Parameter	Value	Unit
$V_{DS} @ T_{j,max}$	650	V
$R_{DS(on),max}$	0.36	Ω
$V_{TH,typ}$	3	V
I_D	11	A
$Q_{g,typ}$	19.4	nC

■ Package & Internal Circuit



■ Features

- Low Power Loss by High Speed Switching and Low On-Resistance
- Excellent ESD robustness
- 100% Avalanche Tested
- Green Package-Pb Free Plating, Halogen Free
- Zener-Integrated

■ Applications

- PFC Power Supply Stages
- Switching Applications
- Adapter
- DC-DC Converters

■ Ordering Information

Order Code	Marking	Temp. Range	Package	Packing	RoHS Status
MMF60R360RZTH	60R360RZ	-55 ~ 150°C	TO-220F	Tube	Compliant

■ Absolute Maximum Rating ($T_c=25^\circ\text{C}$ unless otherwise specified)

Parameter	Symbol	Rating	Unit	Note
Drain - Source voltage	V_{DSS}	600	V	
Gate - Source voltage	V_{GSS}	± 25	V	
Continuous drain current ⁽¹⁾	I_D	11	A	$T_c=25^\circ\text{C}$
		7	A	$T_c=100^\circ\text{C}$
Pulsed drain current ⁽²⁾	I_{DM}	33	A	
Power dissipation	P_D	30.5	W	
Single - pulse avalanche energy ⁽³⁾	E_{AS}	210	mJ	
MOSFET dv/dt ruggedness	dv/dt	50	V/ns	
Diode dv/dt ruggedness ⁽⁴⁾	dv/dt	15	V/ns	
Storage temperature	T_{stg}	-55 ~150	$^\circ\text{C}$	
Maximum operating junction temperature	T_j	150	$^\circ\text{C}$	

- 1) I_D limited by maximum junction temperature
- 2) Pulse width t_P limited by $T_{j,max}$
- 3) $I_{AS} : 1.5\text{A}$
- 4) $I_{SD} \leq I_D, V_{DS\ peak} \leq V_{(BR)DSS}$

■ Thermal Characteristics

Parameter	Symbol	Value	Unit
Thermal resistance, junction-case max	R_{thjc}	4.10	$^\circ\text{C/W}$
Thermal resistance, junction-ambient max	R_{thja}	63.6	$^\circ\text{C/W}$

■ Static Characteristics (T_c=25°C unless otherwise specified)

Parameter	Symbol	Min.	Typ.	Max.	Unit	Test Condition
Drain - Source Breakdown voltage	V _{(BR)DSS}	600	-	-	V	V _{GS} = 0V, I _D = 1mA
Gate Threshold Voltage	V _{GS(th)}	2	3	4	V	V _{DS} = V _{GS} , I _D = 250μA
Zero Gate Voltage Drain Current	I _{DSS}	-	-	1	μA	V _{DS} = 600V, V _{GS} = 0V
Gate Leakage Current	I _{GSS}	-	-	10	μA	V _{GS} = ±25V, V _{DS} = 0V
Drain - Source On State Resistance	R _{DS(ON)}	-	0.32	0.36	Ω	V _{GS} = 10V, I _D = 3.8A

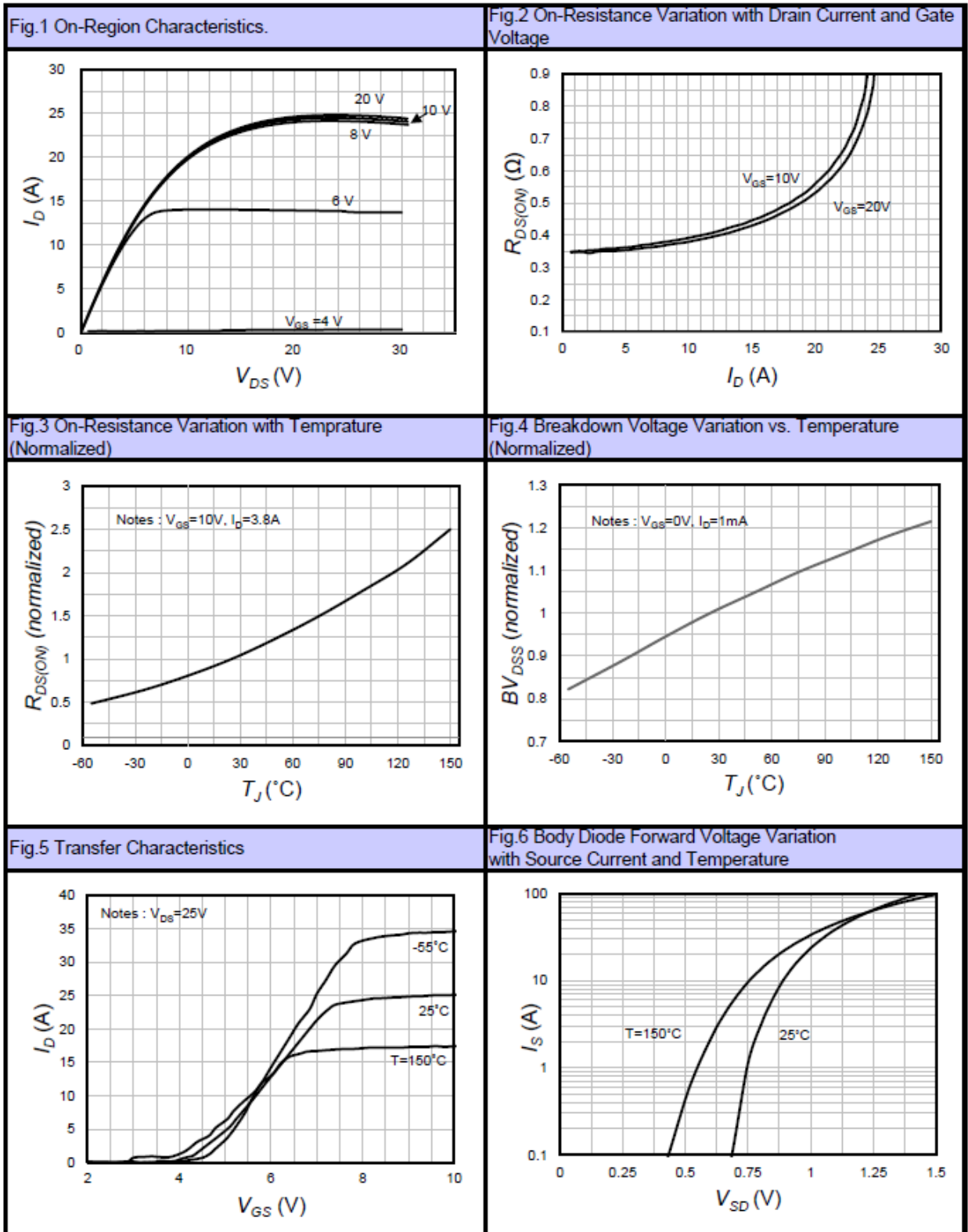
■ Dynamic Characteristics (T_c=25°C unless otherwise specified)

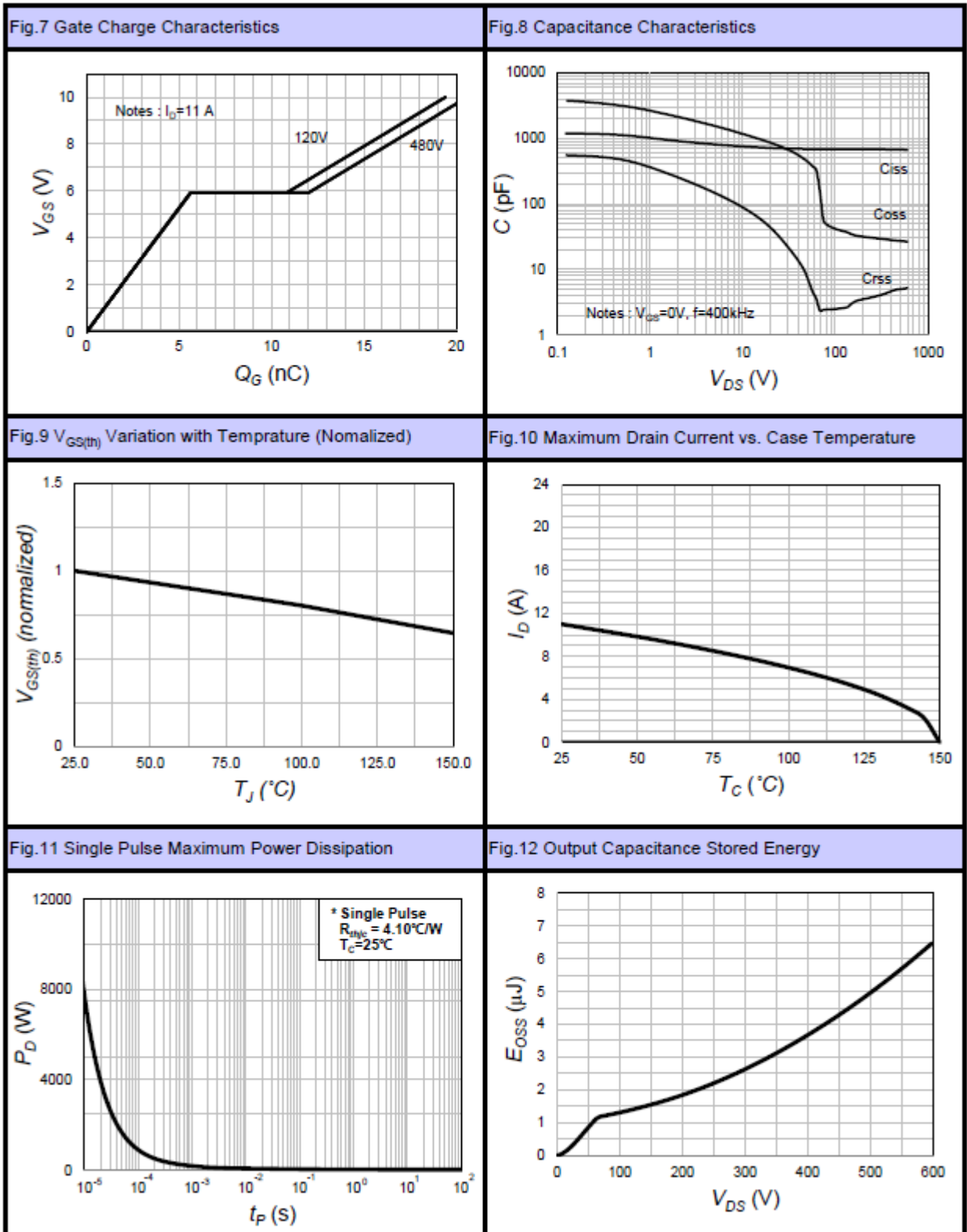
Parameter	Symbol	Min.	Typ.	Max.	Unit	Test Condition
Input Capacitance	C _{iss}	-	680	-	pF	V _{DS} = 400V, V _{GS} = 0V, f = 400kHz
Output Capacitance	C _{oss}	-	28.2	-		
Reverse Transfer Capacitance	C _{rss}	-	4.56	-		
Effective Output Capacitance Energy Related ⁽⁵⁾	C _{o(er)}	-	40.5	-		
Turn On Delay Time	t _{d(on)}	-	18	-	ns	V _{GS} = 10V, R _G = 25Ω, V _{DS} = 300V, I _D = 11A
Rise Time	t _r	-	32.3	-		
Turn Off Delay Time	t _{d(off)}	-	68	-		
Fall Time	t _f	-	28	-		
Total Gate Charge	Q _g	-	19.4	-	nC	V _{GS} = 10V, V _{DS} = 480V, I _D = 11A
Gate - Source Charge	Q _{gs}	-	5.9	-		
Gate - Drain Charge	Q _{gd}	-	7.9	-		
Gate Resistance	R _G	-	8.6	-	Ω	V _{GS} = 0V, f = 1MHz

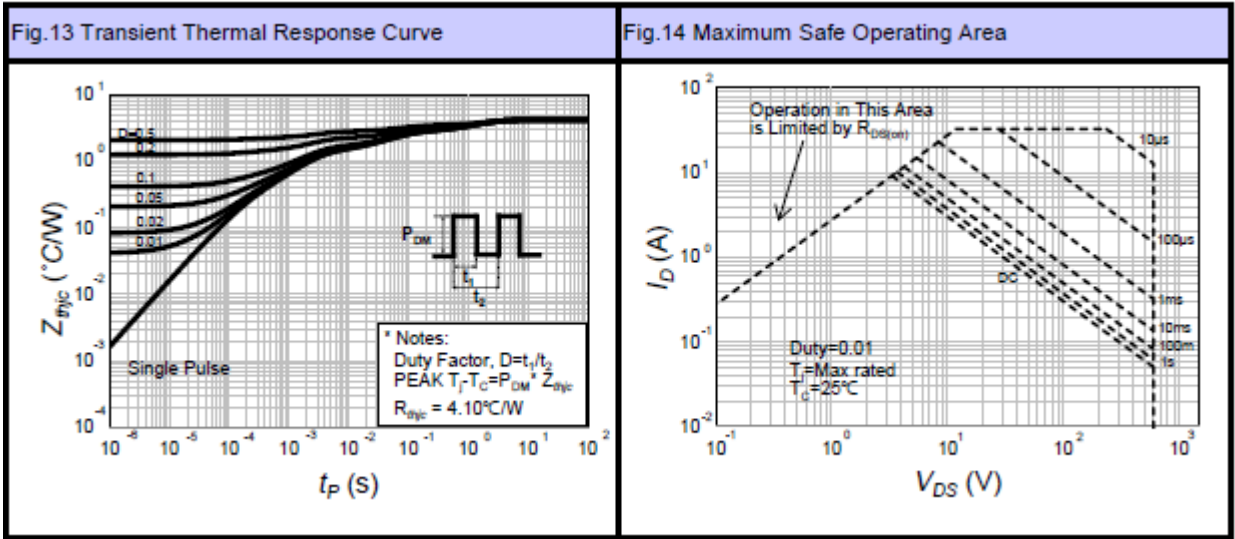
5) C_{o(er)} is a capacitance that gives the same stored energy as C_{oss} while V_{DS} is rising from 0V to 80% V_{(BR)DSS}

■ Reverse Diode Characteristics ($T_c=25^\circ\text{C}$ unless otherwise specified)

Parameter	Symbol	Min.	Typ.	Max.	Unit	Test Condition
Continuous Diode Forward Current	I_{SD}	-	-	11	A	
Diode Forward Voltage	V_{SD}	-	-	1.4	V	$I_{SD} = 11\text{A}$, $V_{GS} = 0\text{V}$
Reverse Recovery Time	t_{rr}	-	313	-	ns	$I_{SD} = 11\text{A}$ $di/dt = 100\text{A}/\mu\text{s}$ $V_{DD} = 100\text{V}$
Reverse Recovery Charge	Q_{rr}	-	3.2	-	μC	
Reverse Recovery Current	I_{rrm}	-	20.7	-	A	

■ Characteristic Graph






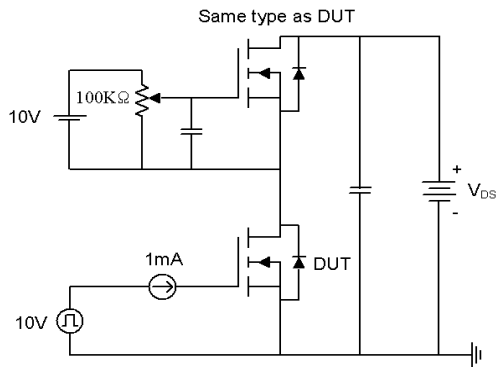
■ Test Circuit


Fig15-1. Gate charge measurement circuit

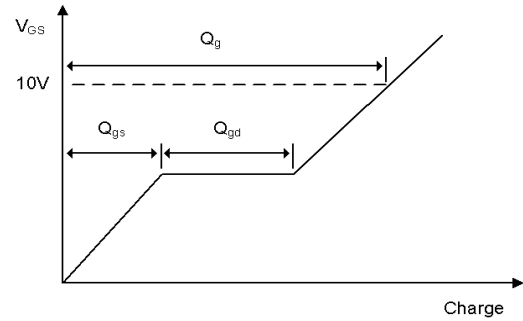


Fig15-2. Gate charge waveform

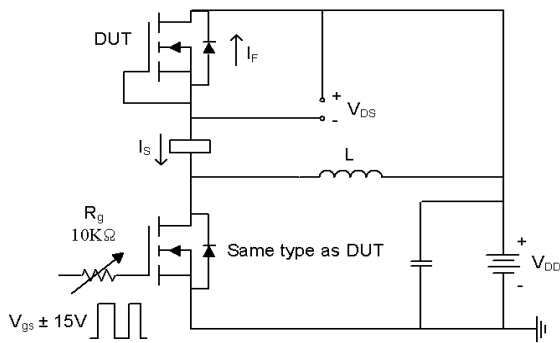


Fig16-1. Diode reverse recovery test circuit

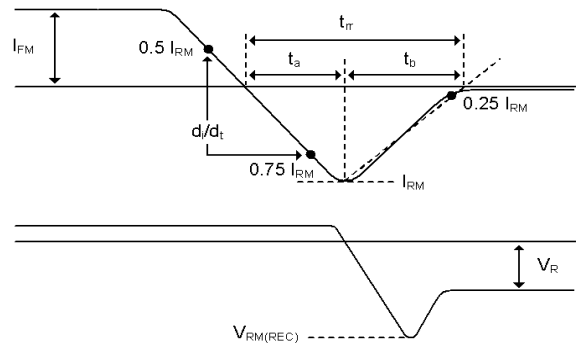


Fig16-2. Diode reverse recovery test waveform

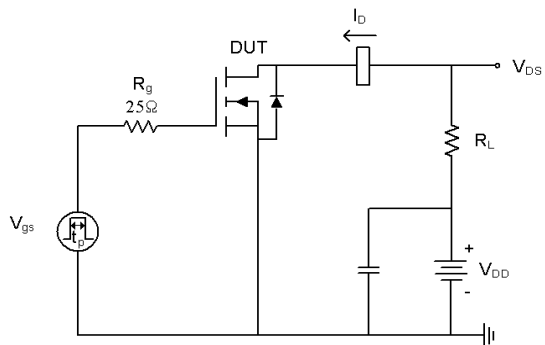


Fig17-1. Switching time test circuit for resistive load

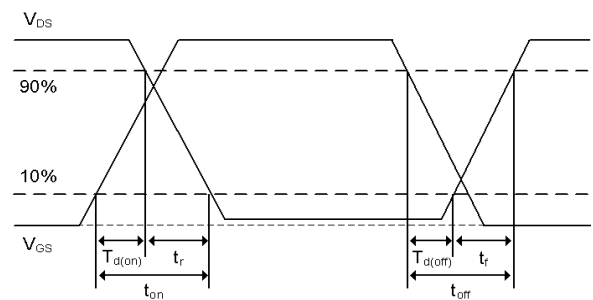


Fig17-2. Switching time waveform

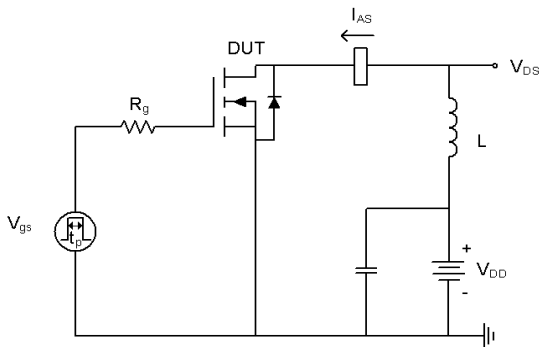


Fig18-1. Unclamped inductive load test circuit

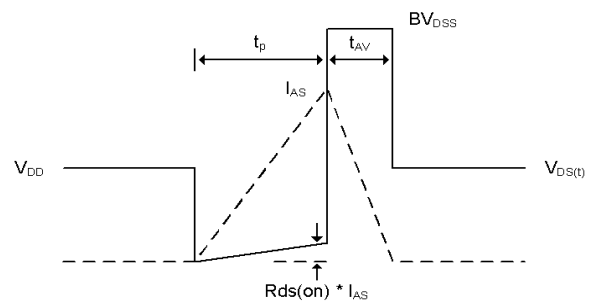
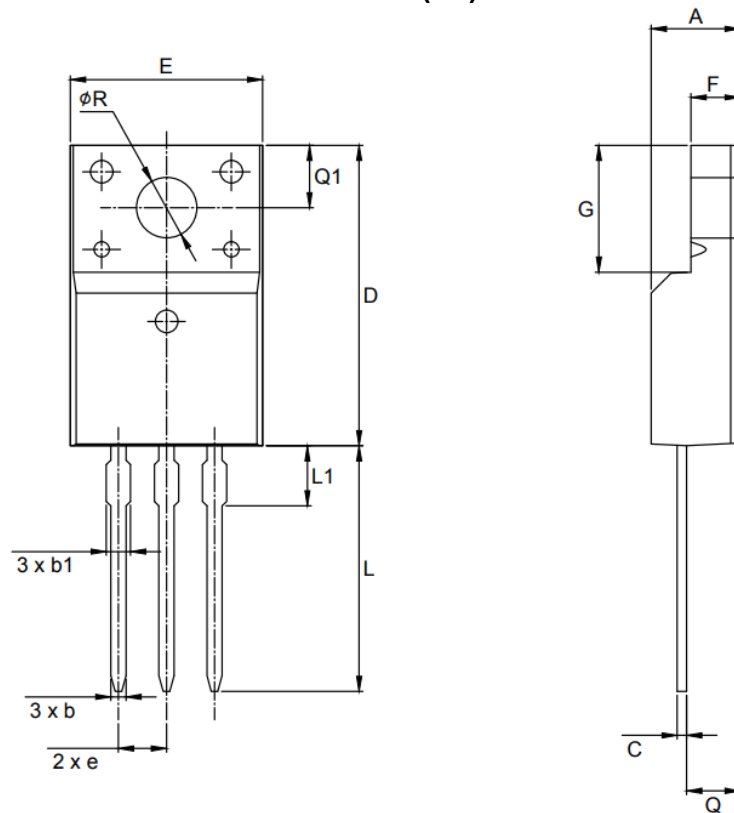


Fig18-2. Unclamped inductive waveform


■ Physical Dimension
TO-220F (3L)


Note : Package body size, length and width do not include mold flash, protrusions and gate burrs.

Symbol	Dimension (mm)		
	Min	Nom	Max
A	4.50	-	4.93
b	0.63	-	0.91
b1	1.15	-	1.47
C	0.33	-	0.63
D	15.47	-	16.13
E	9.60	-	10.71
e	2.54 BSC		
F	2.34	-	2.84
G	6.48	-	6.90
L	12.24	-	13.72
L1	2.79	-	3.67
Q	2.52	-	2.96
Q1	3.10	-	3.50
φR	3.00	-	3.55

DISCLAIMER:

The Products are not designed for use in hostile environments, including, without limitation, aircraft, nuclear power generation, medical appliances, and devices or systems in which malfunction of any Product can reasonably be expected to result in a personal injury. Seller's customers using or selling Seller's products for use in such applications do so at their own risk and agree to fully defend and indemnify Seller.

Magnachip reserves the right to change the specifications and circuitry without notice at any time. Magnachip does not consider responsibility for use of any circuitry other than circuitry entirely included in a Magnachip product. is  Magnachip a registered trademark of Magnachip Semiconductor Ltd.