



MDD10N074RH

Single N-channel Trench MOSFET 100V 7.8mΩ 60A

FEATURES

- Trench power MOSFET technology
- Very low on-resistance $R_{DS(on)}$
- 100% Avalanche / Rg Tested

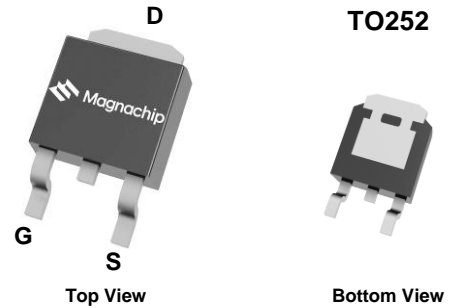

APPLICATIONS

- Specifically for Synchronous Rectification
- Switching Applications

KEY PERFORMANCE PARAMETERS

V_{DS}	100	V
$R_{DS(on), typ.}$	0.0068	Ω
I_D	60	A
Q_G	72	nC
Junction temperature, $_{max}$	150	$^{\circ}C$

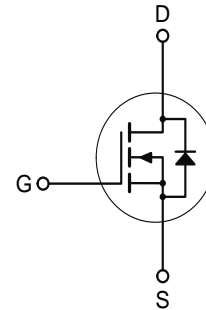

ORDERING INFORMATION

Type / Ordering Code	Package	Marking	Packing	RoHS Status
MDD10N074RH	TO252	MDD10N074	Tape & Reel	Halogen Free

<http://www.magnachip.com>

ABSOLUTE MAXIMUM RATINGS, at $T_c = 25^\circ\text{C}$, unless otherwise specified

PARAMETER		SYMBOL	RATING	UNIT
Drain-source Voltage		V_{DS}	100	V
Gate-source Voltage		V_{GS}	± 20	V
Drain current	$T_c=25^\circ\text{C}$ Silicon Limited	I_D	77	A
	$T_c=25^\circ\text{C}$ Package Limited		60	A
	$T_c=100^\circ\text{C}$ Silicon Limited		49	A
¹⁾ Pulsed drain current	$T_c=25^\circ\text{C}$	I_{DM}	240	A
Total power dissipation	$T_c=25^\circ\text{C}$	P_{tot}	96	W
	$T_c=100^\circ\text{C}$		38	W
²⁾ Avalanche energy, single pulse		E_{AS}	113	mJ
Operating and storage temperature		T_j, T_{stg}	- 55 ~ 150	$^\circ\text{C}$

THERMAL CHARACTERISTICS

PARAMETER		SYMBOL	RATING	UNIT
Thermal resistance, junction - case		$R_{\theta JC}$	1.3	$^\circ\text{C/W}$
³⁾ Thermal resistance, junction - ambient		$R_{\theta JA}$	40	$^\circ\text{C/W}$

ELECTRICAL CHARACTERISTICS (T_j = 25°C)**STATIC CHARACTERISTICS**

PARAMETER	SYMBOL	MIN.	TYP.	MAX.	UNIT	CONDITIONS / NOTE
Drain-source breakdown voltage	V _{(BR)DSS}	100	-	-	V	V _{GS} =0 V, I _D =250 μA
Gate threshold voltage	V _{GS(th)}	1.2	1.6	2.2	V	V _{DS} =V _{GS} , I _D =250 μA
Zero gate voltage drain current	I _{DSS}	-	-	1	μA	V _{DS} =100 V, V _{GS} =0 V
Gate-source leakage current	I _{GSS}	-	-	± 100	nA	V _{GS} =±20 V, V _{DS} =0 V
Drain-source on-state resistance	R _{DS(on)}	-	6.8	7.8	mΩ	V _{GS} =10 V, I _D =20 A
		-	7.9	9.4	mΩ	V _{GS} =4.5 V, I _D =15 A
⁴⁾ Gate resistance	R _G		2.1		Ω	f=1MHz
⁴⁾ Transconductance	g _{fs}	-	92	-	S	V _{DS} =10 V, I _D =20 A

⁴⁾ DYNAMIC CHARACTERISTICS

PARAMETER	SYMBOL	MIN.	TYP.	MAX.	UNIT	CONDITIONS / NOTE
Input capacitance	C _{iss}	-	4396	-	pF	V _{GS} =0 V, V _{DS} =40 V, f=1 MHz
Output capacitance	C _{oss}	-	511	-	pF	V _{GS} =0 V, V _{DS} =40 V, f=1 MHz
Reverse transfer capacitance	C _{rss}	-	30	-	pF	V _{GS} =0 V, V _{DS} =40 V, f=1 MHz
Turn-on delay time	t _{d(on)}	-	18.0	-	ns	V _{DD} =50 V, V _{GS} =10 V, I _D =20 A, R _{G,ext} =3Ω
Rise time	t _r	-	7	-	ns	V _{DD} =50 V, V _{GS} =10 V, I _D =20 A, R _{G,ext} =3Ω
Turn-off delay time	t _{d(off)}	-	88	-	ns	V _{DD} =50 V, V _{GS} =10 V, I _D =20 A, R _{G,ext} =3Ω
Fall time	t _f	-	21.0	-	ns	V _{DD} =50 V, V _{GS} =10 V, I _D =20 A, R _{G,ext} =3Ω

⁴⁾ GATE CHARGE CHARACTERISTICS

PARAMETER	SYMBOL	MIN.	TYP.	MAX.	UNIT	CONDITIONS / NOTE
Gate to source charge	Q _{gs}	-	11	-	nC	V _{DD} =50 V, I _D =20 A, V _{GS} =0 to 10 V
Gate to drain charge	Q _{gd}	-	14	-	nC	V _{DD} =50 V, I _D =20 A, V _{GS} =0 to 10 V
Gate charge total	Q _g	-	72	-	nC	V _{DD} =50 V, I _D =20 A, V _{GS} =0 to 10 V

SOURCE-DRAIN DIODE

PARAMETER	SYMBOL	MIN.	TYP.	MAX.	UNIT	CONDITIONS / NOTE
⁴⁾ Diode continuous forward current	I _S	-	-	60	A	-
⁴⁾ Diode pulse current	I _{S,pulse}	-	-	240	A	pulsed; t _p ≤ 10 μs
Diode forward voltage	V _{SD}	-	0.8	1.2	V	V _{GS} =0 V, I _S =20 A
⁴⁾ Reverse recovery time	t _{rr}	-	69	-	ns	I _F =20 A, d _I /dt=100 A/μs
⁴⁾ Reverse recovery charge	Q _{rr}	-	143	-	nC	I _F =20 A, d _I /dt=100 A/μs

Notes

- Pulse width limited by T_{jmax}
- starting T_j = 25°C, L = 1.0mH, I_{AS} = 15A, V_{DD} = 50V, V_{GS} = 10V
- Surface mounted FR-4 board by JEDEC (jesd51-7)
- The parameter is not subject to production testing - guaranteed by design.

ELECTRICAL CHARACTERISTICS DIAGRAMS (25 °C, unless otherwise noted)

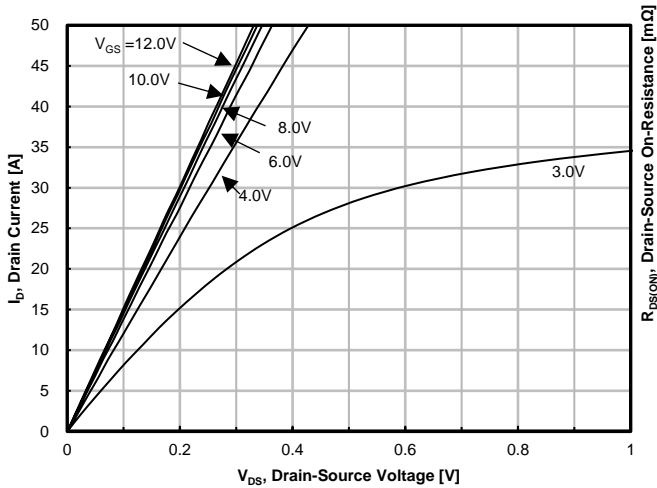

Fig. 1. On-Region Characteristics

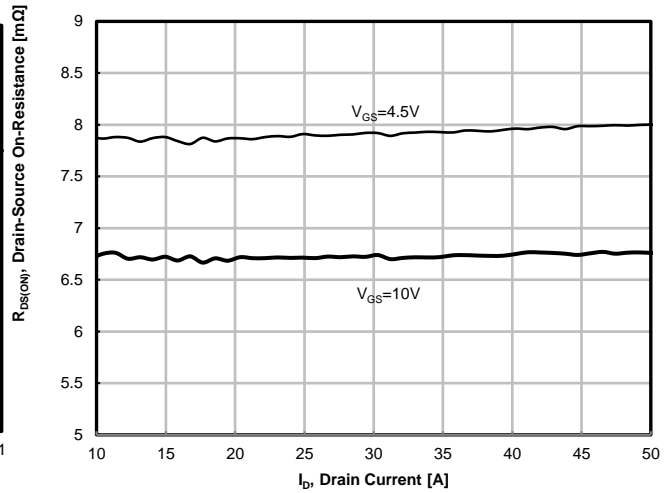

Fig. 2. On-Resistance vs. Drain Current and Gate Voltage

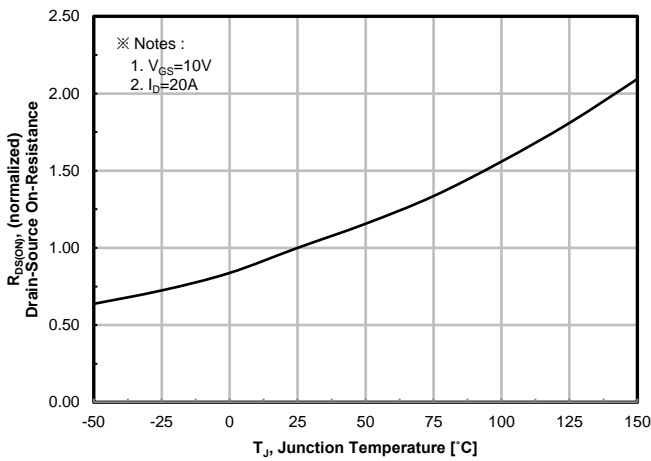

Fig. 3. On-Resistance vs. Junction Temperature

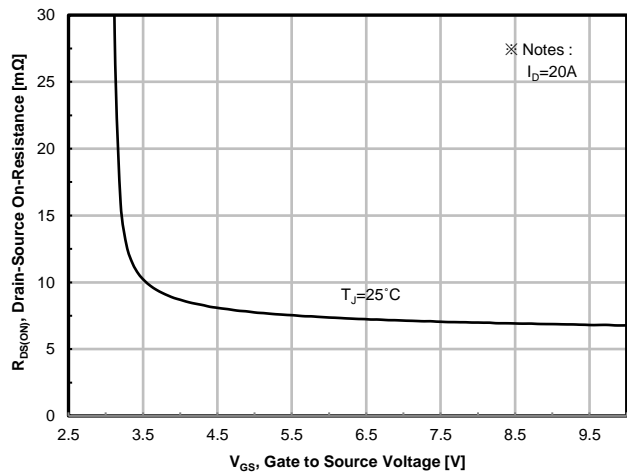

Fig. 4. On-Resistance vs. Gate to Source Voltage

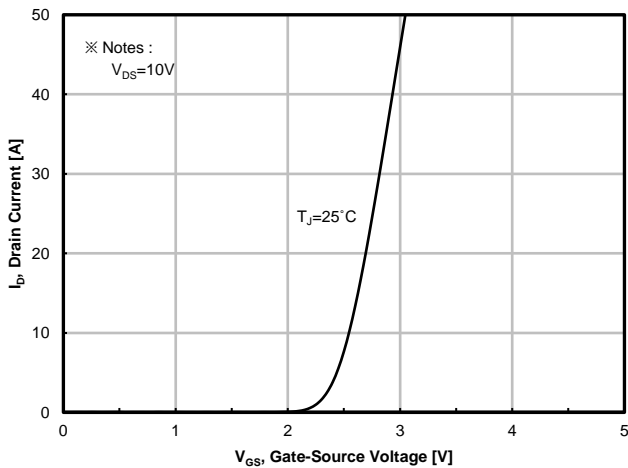

Fig. 5. Transfer Characteristics

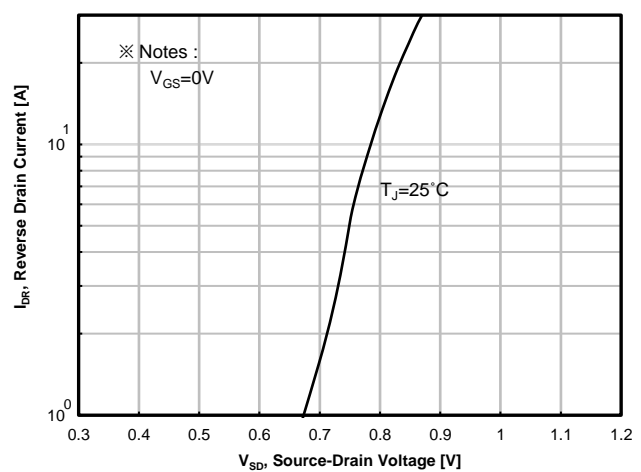

Fig. 6. Source-Drain Diode Forward Voltage

ELECTRICAL CHARACTERISTICS DIAGRAMS (25 °C, unless otherwise noted)

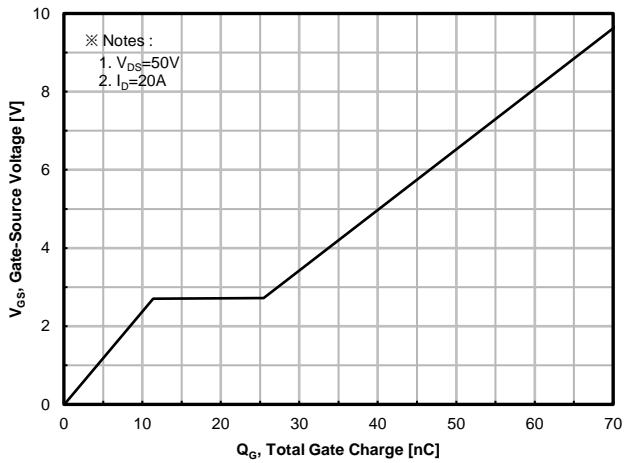

Fig. 7. Gate Charge

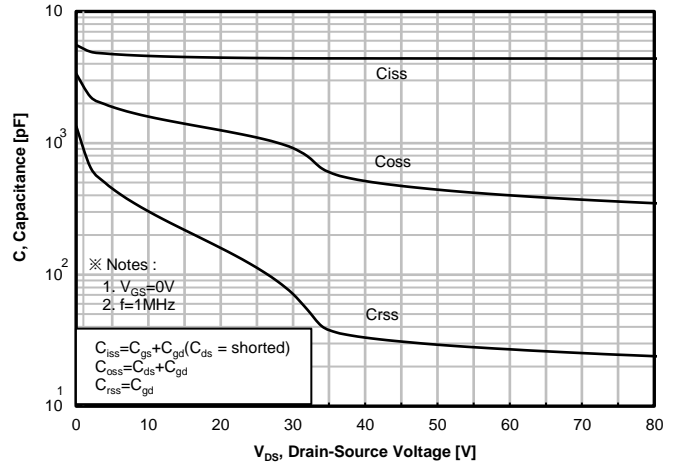

Fig. 8. Capacitance

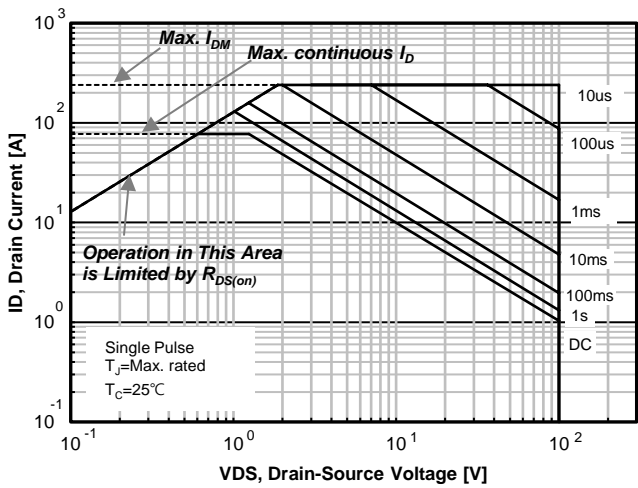

Fig. 9. Safe Operating Area

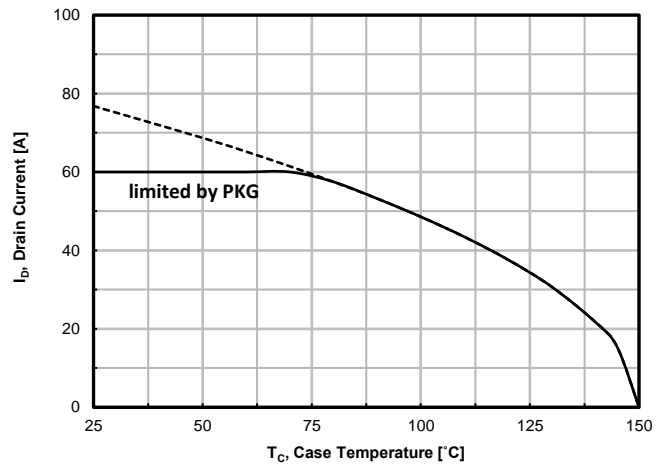

Fig. 10. Maximum Drain Current vs. Case Temperature

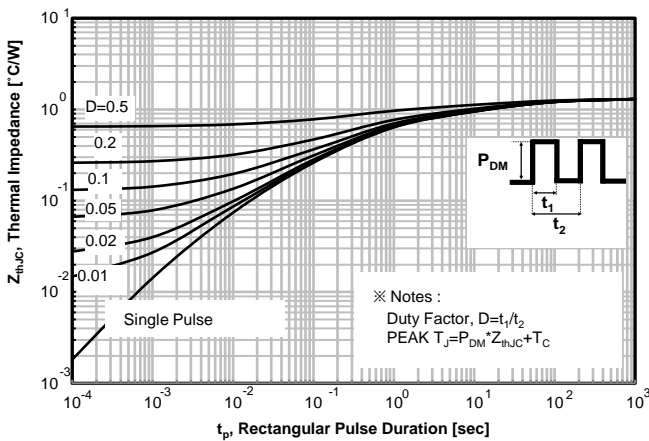
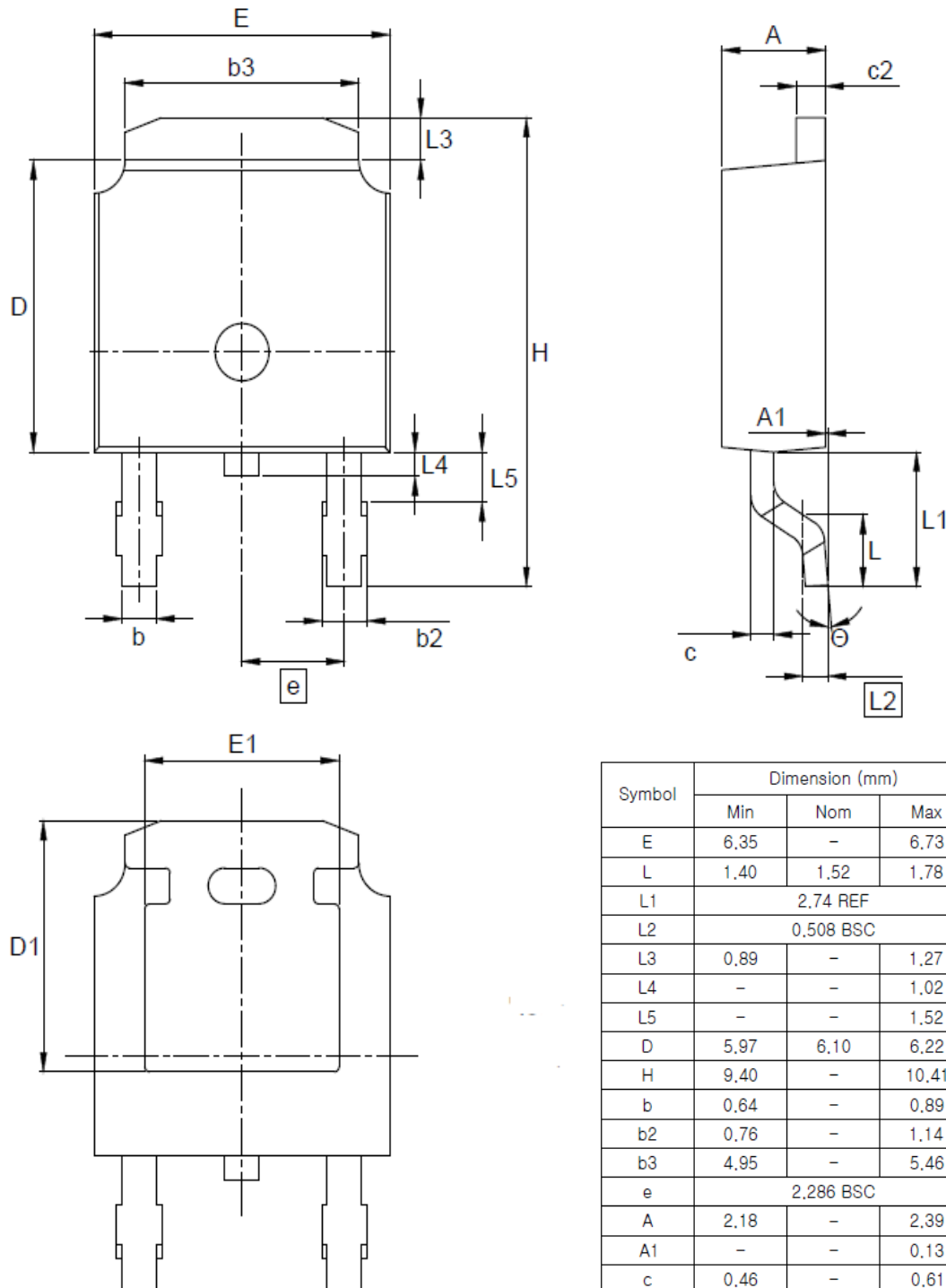

Fig. 11. Thermal Transient Impedance, Junction-to-Ambient

Package information

T0252



Symbol	Dimension (mm)		
	Min	Nom	Max
E	6.35	-	6.73
L	1.40	1.52	1.78
L1	2.74 REF		
L2	0.508 BSC		
L3	0.89	-	1.27
L4	-	-	1.02
L5	-	-	1.52
D	5.97	6.10	6.22
H	9.40	-	10.41
b	0.64	-	0.89
b2	0.76	-	1.14
b3	4.95	-	5.46
e	2.286 BSC		
A	2.18	-	2.39
A1	-	-	0.13
c	0.46	-	0.61
c2	0.46	-	0.89
D1	5.21	-	-
E1	4.32	-	-
θ	0°	-	10°

Notes :

1. Package body size , length and width do not includes mold flash, protrusions and gate burrs.

DISCLAIMER :

The Products are not designed for use in hostile environments, including, without limitation, aircraft, nuclear power generation, medical appliances, and devices or systems in which malfunction of any Product can reasonably be expected to result in a personal injury. Seller's customers using or selling Seller's products for use in such applications do so at their own risk and agree to fully defend and indemnify Seller.

Magnachip reserves the right to change the specifications and circuitry without notice at any time. Magnachip does not consider responsibility for use of any circuitry other than circuitry entirely included in a Magnachip product.  Magnachip is a registered trademark of Magnachip Semiconductor Ltd.