



# MDD08N067RH

## Single N-channel Trench MOSFET 78V 6.7mΩ 70A

### General description

The MDD08N067RH uses advanced Magnachip's MV MOSFET Technology, which provides high performance in on-state resistance, fast switching performance, and excellent quality.

MDD08N067RH is suitable device for Motor Drive applications and general purpose applications.

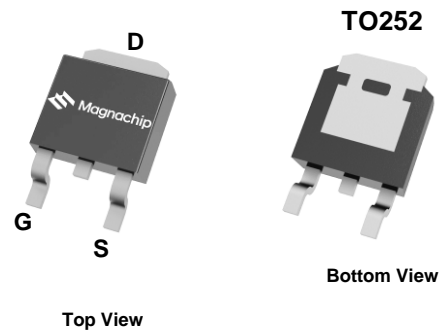

### Features and benefits

- Magnachip's MOSFET Technology
- Very low on-resistance  $R_{DS(on)}$
- 100% Avalanche / Rg Tested

### Applications

- Specifically for E-Bike applications
- Switching Applications
- Drives

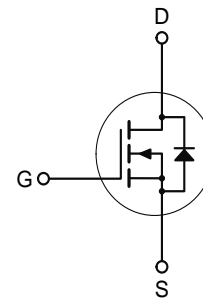

### Key performance parameters

$V_{DS}$	78	V
$R_{DS(on), max}$	0.0067	$\Omega$
$I_D$	70	A
$Q_G$	43.3	nC
Junction temperature <sub>max</sub>	175	$^{\circ}C$



### Ordering information

Type / Ordering Code	Package	Marking	Packing	RoHS Status
MDD08N067RH	TO252	08N067	Tape & Reel	Halogen Free

<http://www.magnachip.com/powersolutions>



**Maximum ratings**, at  $T_A = 25^\circ\text{C}$ , unless otherwise specified

Parameter	Symbol	Rating	Unit	
Drain-source Voltage	$V_{DS}$	78	V	
Gate-source Voltage	$V_{GS}$	$\pm 20$	V	
Drain current	$I_D$	$T_C=25^\circ\text{C}$ Silicon Limited	101	A
		$T_C=25^\circ\text{C}$ Package Limited	70	A
		$T_C=100^\circ\text{C}$ Silicon Limited	71	A
<sup>1)</sup> Pulsed drain current	$I_{DM}$	280	A	
Total power dissipation	$P_{tot}$	$T_C=25^\circ\text{C}$	138	W
		$T_C=100^\circ\text{C}$	69	W
<sup>2)</sup> Avalanche energy, single pulse	$E_{AS}$	128	mJ	
Operating and storage temperature	$T_j, T_{stg}$	- 55 ~ 175	$^\circ\text{C}$	

**Thermal characteristics**

Parameter	Symbol	Rating	Unit
Thermal resistance, junction - case	$R_{\theta JC}$	1.1	$^\circ\text{C/W}$
<sup>3)</sup> Thermal resistance, junction - ambient	$R_{\theta JA}$	30	$^\circ\text{C/W}$

**Notes**

- Pulse width limited by  $T_{jmax}$
- EAS is tested at starting  $T_j = 25^\circ\text{C}$ ,  $L = 1.0\text{mH}$ ,  $I_{AS} = 16.5\text{A}$ ,  $V_{DD} = 50\text{V}$ ,  $V_{GS} = 10\text{V}$
- Surface mounted FR-4 board by JEDEC (jesd51-7)

Electrical Characteristics ( $T_J = 25^\circ\text{C}$ )

## Static characteristics

Parameter	Symbol	Min.	Typ.	Max.	Unit	Conditions / Note
Drain-source breakdown voltage	$V_{(BR)DSS}$	78	-	-	V	$V_{GS}=0\text{ V}$ , $I_D=250\ \mu\text{A}$
Gate threshold voltage	$V_{GS(th)}$	2.3	3.0	3.7	V	$V_{DS}=V_{GS}$ , $I_D=250\ \mu\text{A}$
Zero gate voltage drain current	$I_{DSS}$	-	-	1	$\mu\text{A}$	$V_{DS}=78\text{ V}$ , $V_{GS}=0\text{ V}$
Gate-source leakage current	$I_{GSS}$	-	-	$\pm 100$	nA	$V_{GS}=\pm 20\text{ V}$ , $V_{DS}=0\text{ V}$
Drain-source on-state resistance	$R_{DS(on)}$	-	5.6	6.7	m $\Omega$	$V_{GS}=10\text{ V}$ , $I_D=35\text{ A}$
Gate resistance	$R_G$	-	2.5	-	$\Omega$	$f=1\text{ MHz}$
Transconductance	$g_{fs}$	-	60	-	S	$V_{DS}=10\text{ V}$ , $I_D=35\text{ A}$

## Dynamic characteristics

Parameter	Symbol	Min.	Typ.	Max.	Unit	Conditions / Note
Input capacitance	$C_{iss}$	-	2911	-	pF	$V_{GS}=0\text{ V}$ , $V_{DS}=39\text{ V}$ , $f=1\text{ MHz}$
Output capacitance	$C_{oss}$	-	630	-	pF	$V_{GS}=0\text{ V}$ , $V_{DS}=39\text{ V}$ , $f=1\text{ MHz}$
Reverse transfer capacitance	$C_{rfs}$	-	37	-	pF	$V_{GS}=0\text{ V}$ , $V_{DS}=39\text{ V}$ , $f=1\text{ MHz}$
Turn-on delay time	$t_{d(on)}$	-	17	-	ns	$V_{DD}=39\text{ V}$ , $V_{GS}=10\text{ V}$ , $I_D=35\text{ A}$ , $R_{G,ext}=3\ \Omega$
Rise time	$t_r$	-	11	-	ns	$V_{DD}=39\text{ V}$ , $V_{GS}=10\text{ V}$ , $I_D=35\text{ A}$ , $R_{G,ext}=3\ \Omega$
Turn-off delay time	$t_{d(off)}$	-	38	-	ns	$V_{DD}=39\text{ V}$ , $V_{GS}=10\text{ V}$ , $I_D=35\text{ A}$ , $R_{G,ext}=3\ \Omega$
Fall time	$t_f$	-	14	-	ns	$V_{DD}=39\text{ V}$ , $V_{GS}=10\text{ V}$ , $I_D=35\text{ A}$ , $R_{G,ext}=3\ \Omega$

## Gate charge characteristics

Parameter	Symbol	Min.	Typ.	Max.	Unit	Conditions / Note
Gate to source charge	$Q_{GS}$	-	11.3	-	nC	$V_{DD}=39\text{ V}$ , $I_D=35\text{ A}$ , $V_{GS}=0\text{ to }10\text{ V}$
Gate charge at threshold	$Q_{GS(th)}$	-	8.6	-	nC	$V_{DD}=39\text{ V}$ , $I_D=35\text{ A}$ , $V_{GS}=0\text{ to }10\text{ V}$
Gate to drain charge	$Q_{gd}$	-	11.6	-	nC	$V_{DD}=39\text{ V}$ , $I_D=35\text{ A}$ , $V_{GS}=0\text{ to }10\text{ V}$
Switching charge	$Q_{sw}$	-	14.7	-	nC	$V_{DD}=39\text{ V}$ , $I_D=35\text{ A}$ , $V_{GS}=0\text{ to }10\text{ V}$
Gate charge total	$Q_g$	-	43.3	-	nC	$V_{DD}=39\text{ V}$ , $I_D=35\text{ A}$ , $V_{GS}=0\text{ to }10\text{ V}$
Gate plateau voltage	$V_{plateau}$	-	4.3	-	V	$V_{DD}=39\text{ V}$ , $I_D=35\text{ A}$ , $V_{GS}=0\text{ to }10\text{ V}$

## Source-drain diode

Parameter	Symbol	Min.	Typ.	Max.	Unit	Conditions / Note
Diode continuous forward current	$I_S$	-	-	70	A	-
Diode pulse current	$I_{S,pulse}$	-	-	280	A	pulsed; $t_p \leq 10\ \mu\text{s}$
Diode forward voltage	$V_{SD}$	-	0.9	1.2	V	$V_{GS}=0\text{ V}$ , $I_F=35\text{ A}$
Reverse recovery time	$t_{rr}$	-	80	-	ns	$I_F=35\text{ A}$ , $dI_F/dt=100\text{ A}/\mu\text{s}$
Reverse recovery charge	$Q_{rr}$	-	167	-	nC	$I_F=35\text{ A}$ , $dI_F/dt=100\text{ A}/\mu\text{s}$

Electrical characteristics diagrams

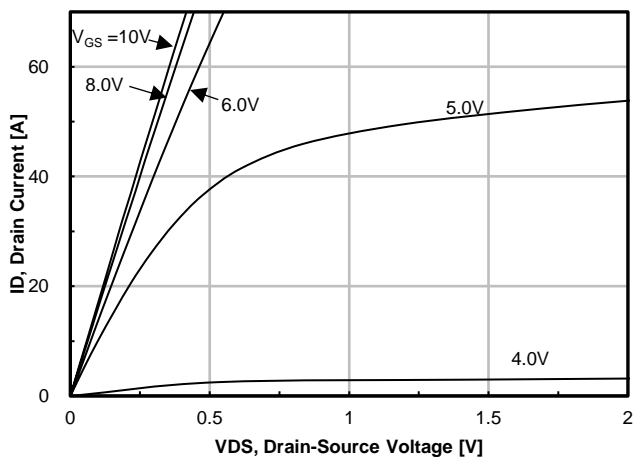

Fig. 1. Output Characteristics

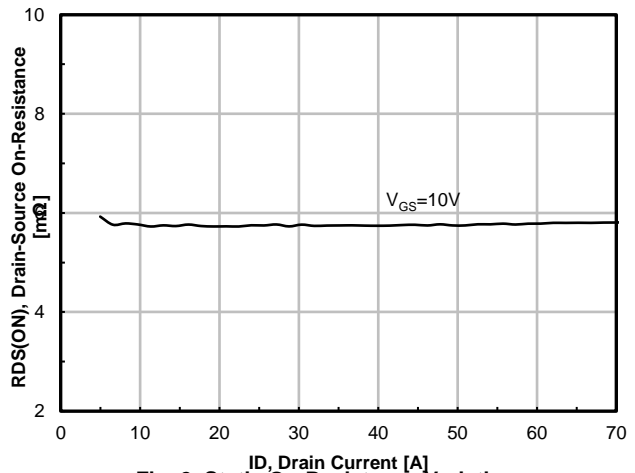

Fig. 2. Static On-Resistance Variation

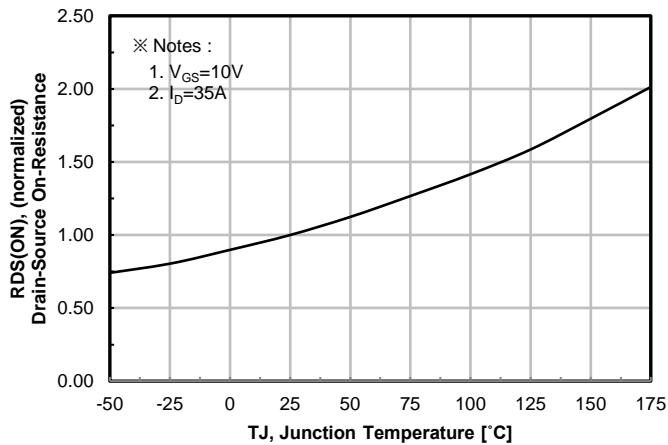

Fig. 3. On-Resistance vs. Junction Temperature

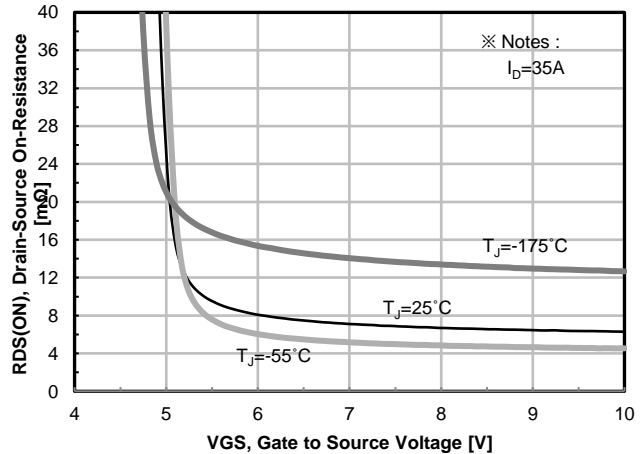

Fig. 4. On-Resistance vs. Gate to Source Voltage

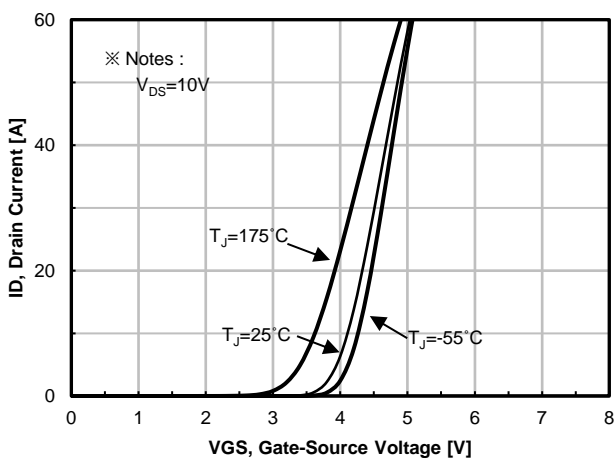

Fig. 5. Transfer Characteristics

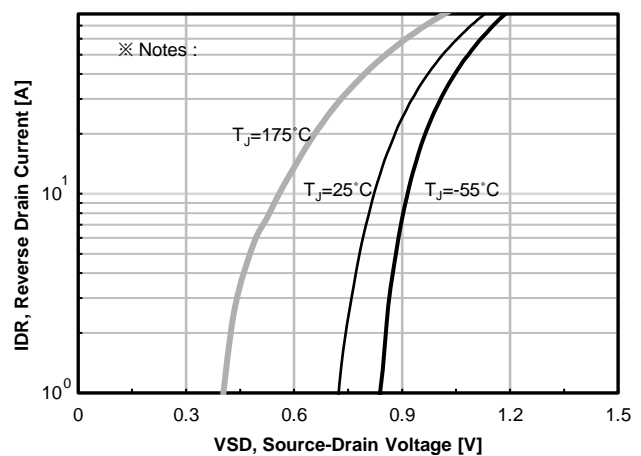
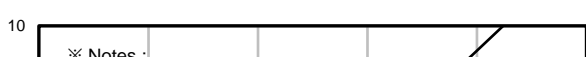

Fig. 6. Body Diode Forward Voltage Variation with Source Current and Temperature



Electrical characteristics diagrams

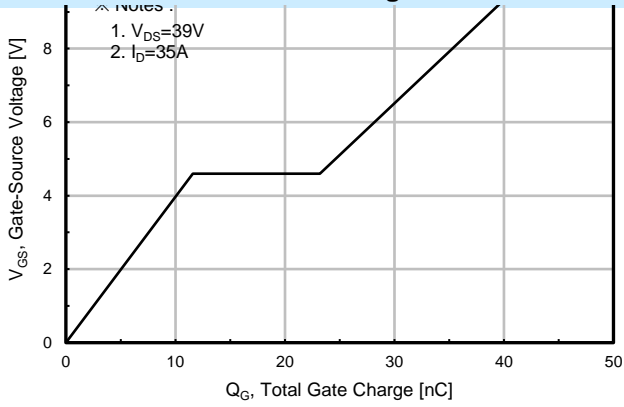

Fig. 7. Gate Charge

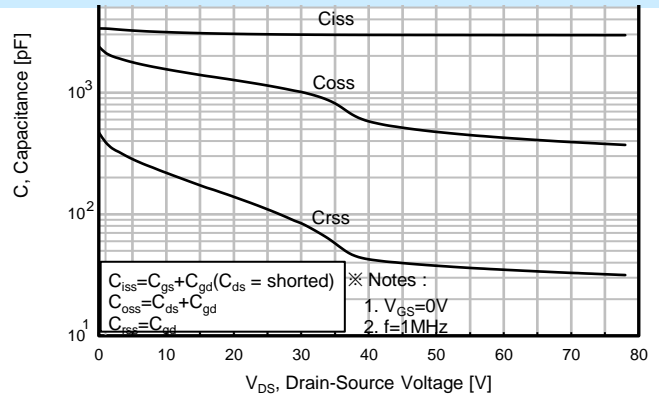

Fig. 8. Capacitance

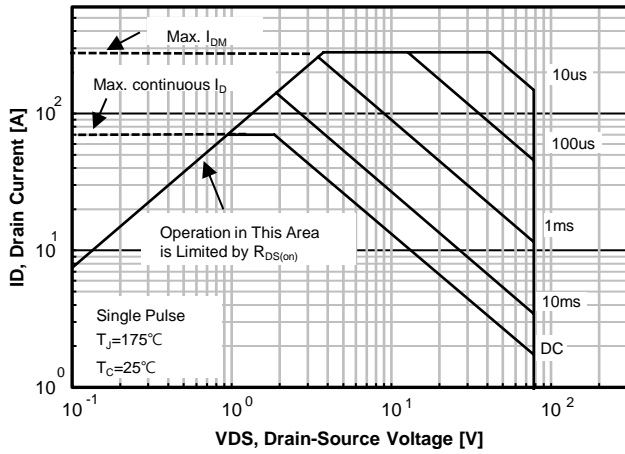

Fig. 9. Safe Operating Area

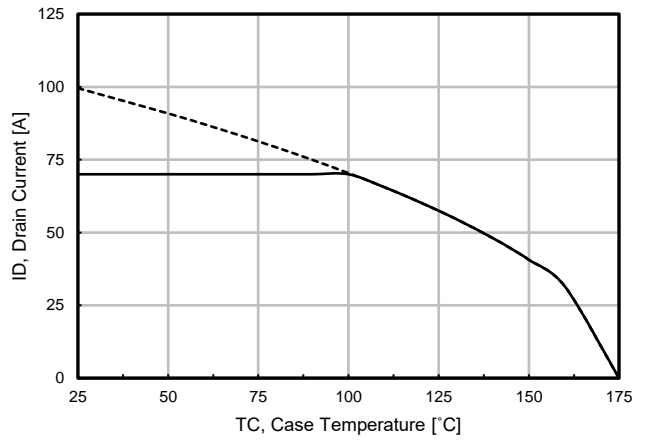

Fig. 10. Maximum Drain Current vs. Case Temperature

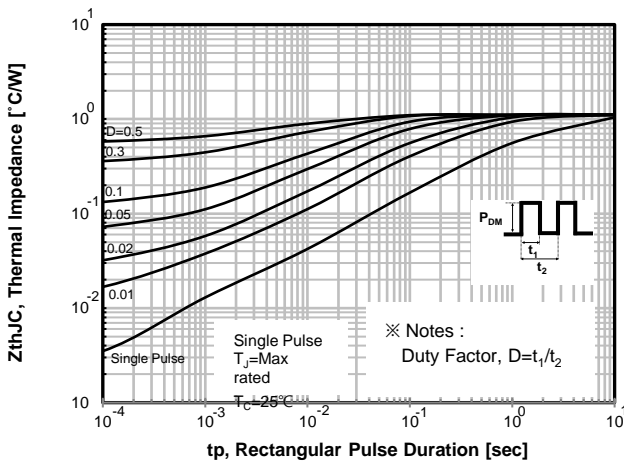
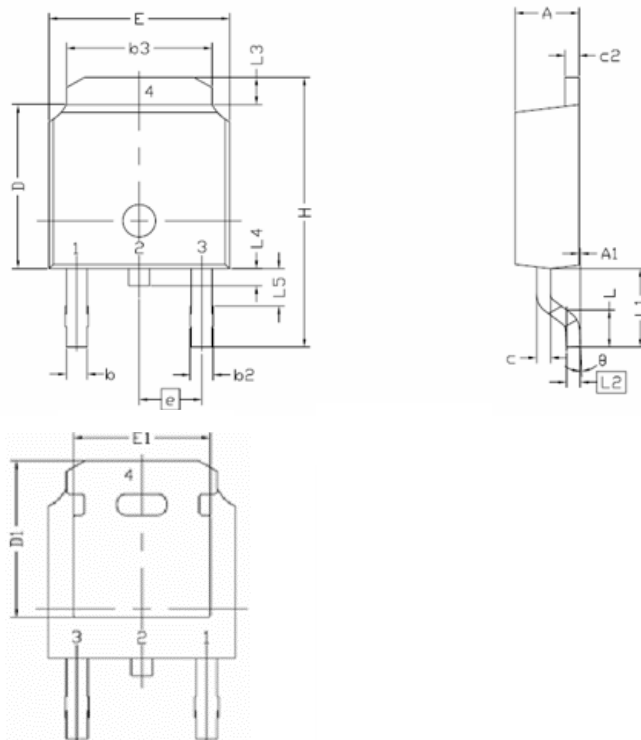

Fig. 11. Transient Thermal Impedance

# Package information

## T0252



Symbol	Min.	Nom.	Max.
E	6,35	-	6,73
L	1,40	1,52	1,78
L1	2,74 REF		
L2	0,508 BCS		
L3	0,89	-	1,27
L4	-	-	1,02
L5	1,14	-	1,52
D	5,97	6,10	6,22
H	9,40	-	10,41
b	0,64	-	0,89
b2	0,76	-	1,14
b3	4,95	-	5,46
e	2,286 BSC		
A	2,18	-	2,39
A1	-	-	0,13
c	0,46	-	0,61
c2	0,46	-	0,89
D1	5,21	-	-
E1	4,32	-	-
⌀	0,00	-	10,00

Note : Package body size, length and width do not include mold flash, protrusions and gate burrs.

**DISCLAIMER :**

The Products are not designed for use in hostile environments, including, without limitation, aircraft, nuclear power generation, medical appliances, and devices or systems in which malfunction of any Product can reasonably be expected to result in a personal injury. Seller's customers using or selling Seller's products for use in such applications do so at their own risk and agree to fully defend and indemnify Seller.

Magnachip reserves the right to change the specifications and circuitry without notice at any time. Magnachip does not consider responsibility for use of any circuitry other than circuitry entirely included in a Magnachip product.  Magnachip is registered trademarks of Magnachip Semiconductor Ltd.