



MDY08N019RH

Single N-channel Trench MOSFET 80V 1.9mΩ 240A

General description

MDY08N019RH uses advanced Magnachip's MV MOSFET Technologies, which provides high performance in on-state resistance, fast switching, parallel performance and excellent quality.

MDY08N019RH is the best solution for high power application where thermal behavior.

Driver source pin avoids gate ringing and false triggering which would normally require switching loss to be limited to manage the source stray inductance of normal package.

Features and benefits

- Very low on-resistance $R_{DS(on)}$
- 100% Avalanche / R_g / ΔV_{DS} Tested
- High Reliability Package Solution

Applications

- Motor Inverter
- Battery Management
- Power Inverter

Key performance parameters

V_{DS}	80	V
$R_{DS(on), max}$	0.0019	Ω
I_D	240	A
Q_G	166	nC
Junction temperature, $_{max}$	175	$^{\circ}C$

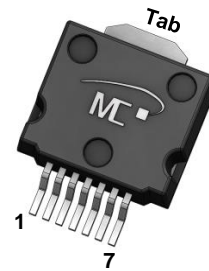

Top View

M2PAK-7P

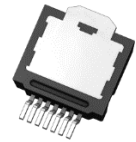

Bottom View

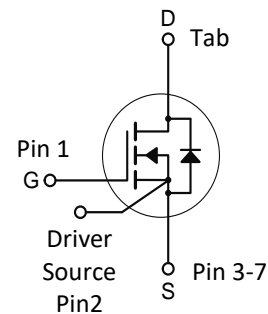

Ordering information

Type / Ordering Code	Package	Marking	Packing	RoHS Status
MDY08N019RH	M2PAK-7P	08N019	Tape & Reel	Halogen Free

<http://www.magnachip.com/powersolutions>



Maximum ratings, at $T_j = 25^\circ\text{C}$, unless otherwise specified

Parameter	Symbol	Rating	Unit
Drain-source Voltage	V_{DS}	80	V
Gate-source Voltage	V_{GS}	± 20	V
Drain current	I_D	$T_C=25^\circ\text{C}$ Silicon Limited	314
		$T_C=25^\circ\text{C}$ Package Limited	240
		$T_C=100^\circ\text{C}$ Silicon Limited	222
¹⁾ Pulsed drain current	I_{DM}	960	A
Total power dissipation	P_{tot}	$T_C=25^\circ\text{C}$	375
		$T_C=100^\circ\text{C}$	188
²⁾ Avalanche energy, single pulse	E_{AS}	800	mJ
Operating and storage temperature	T_j, T_{stg}	- 55 ~ 175	$^\circ\text{C}$

Thermal characteristics

Parameter	Symbol	Rating	Unit
Thermal resistance, junction - case	$R_{\theta JC}$	0.4	$^\circ\text{C}/\text{W}$
³⁾ Thermal resistance, junction - ambient	$R_{\theta JA}$	30	$^\circ\text{C}/\text{W}$

Notes

- Pulse width limited by T_{jmax}
- EAS is tested at starting $T_j = 25^\circ\text{C}$, $L = 1.0\text{mH}$, $I_{AS} = 40\text{A}$, $V_{DD} = 50\text{V}$, $V_{GS} = 10\text{V}$
- Surface mounted FR-4 board by JEDEC (jesd51-7)

Electrical Characteristics (T_J = 25°C)

Static characteristics

Parameter	Symbol	Min.	Typ.	Max.	Unit	Conditions / Note
Drain-source breakdown voltage	V _{(BR)DSS}	80	-	-	V	V _{GS} =0 V, I _D =250 μA
Gate threshold voltage	V _{GS(th)}	2.4	-	3.8	V	V _{DS} =V _{GS} , I _D =250 μA
Zero gate voltage drain current	I _{DSS}	-	-	1	μA	V _{DS} =80 V, V _{GS} =0 V
Gate-source leakage current	I _{GSS}	-	-	± 100	nA	V _{GS} =±20 V, V _{DS} =0 V
Drain-source on-state resistance	R _{DS(on)}	-	1.6	1.9	mΩ	V _{GS} =10 V, I _D =100 A
		-	2.0	3.3	mΩ	V _{GS} =6 V, I _D =50 A
Gate resistance	R _G	-	3.3	-	Ω	f=1MHz
Transconductance	g _{fs}	-	120	-	S	V _{DS} =10 V, I _D =100 A

Dynamic characteristics

Parameter	Symbol	Min.	Typ.	Max.	Unit	Conditions / Note
Input capacitance	C _{iss}	-	12,025	-	pF	V _{GS} =0 V, V _{DS} =40 V, f=1 MHz
Output capacitance	C _{oss}	-	2,634	-	pF	V _{GS} =0 V, V _{DS} =40 V, f=1 MHz
Reverse transfer capacitance	C _{rss}	-	40	-	pF	V _{GS} =0 V, V _{DS} =40 V, f=1 MHz
Turn-on delay time	t _{d(on)}	-	34	-	ns	V _{DD} =40 V, V _{GS} =10 V, I _D =100 A, R _{G,ext} =3Ω
Rise time	t _r	-	25	-	ns	V _{DD} =40 V, V _{GS} =10 V, I _D =100 A, R _{G,ext} =3Ω
Turn-off delay time	t _{d(off)}	-	128	-	ns	V _{DD} =40 V, V _{GS} =10 V, I _D =100 A, R _{G,ext} =3Ω
Fall time	t _f	-	60	-	ns	V _{DD} =40 V, V _{GS} =10 V, I _D =100 A, R _{G,ext} =3Ω

Gate charge characteristics

Parameter	Symbol	Min.	Typ.	Max.	Unit	Conditions / Note
Gate to source charge	Q _{gs}	-	42	-	nC	V _{DD} =40 V, I _D =100 A, V _{GS} =0 to 10 V
Gate charge at threshold	Q _{gs(th)}	-	32	-	nC	V _{DD} =40 V, I _D =100 A, V _{GS} =0 to 10 V
Gate to drain charge	Q _{gd}	-	38	-	nC	V _{DD} =40 V, I _D =100 A, V _{GS} =0 to 10 V
Switching charge	Q _{sw}	-	48	-	nC	V _{DD} =40 V, I _D =100 A, V _{GS} =0 to 10 V
Gate charge total	Q _g	-	166	-	nC	V _{DD} =40 V, I _D =100 A, V _{GS} =0 to 10 V
Gate plateau voltage	V _{plateau}	-	4.4	-	V	V _{DD} =40 V, I _D =100 A, V _{GS} =0 to 10 V

Source-drain diode

Parameter	Symbol	Min.	Typ.	Max.	Unit	Conditions / Note
Diode continuous forward current	I _S	-	-	240	A	-
Diode pulse current	I _{S,pulse}	-	-	960	A	pulsed; t _p ≤ 10 μs
Diode forward voltage	V _{SD}	-	1.0	1.2	V	V _{GS} =0 V, I _F =100 A
Reverse recovery time	t _{rr}	-	136	-	ns	I _F =100 A, d _I /dt=100 A/μs
Reverse recovery charge	Q _{rr}	-	454	-	nC	I _F =100 A, d _I /dt=100 A/μs

Electrical characteristics diagrams

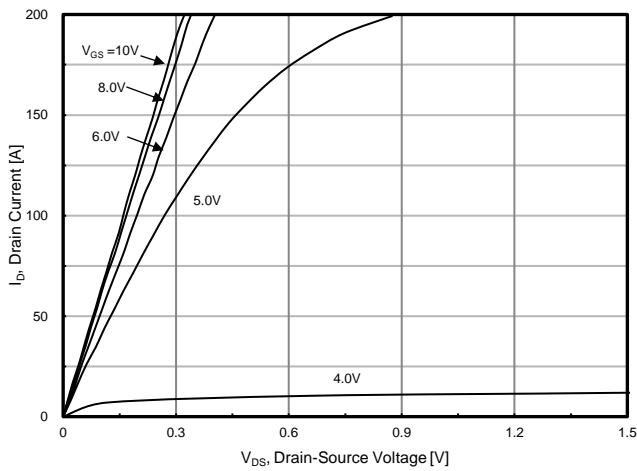

Fig. 1. Output Characteristics

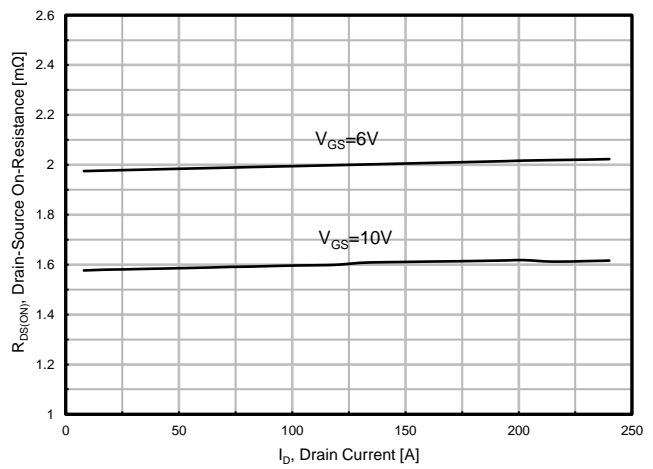

Fig. 2. Static On-Resistance Variation

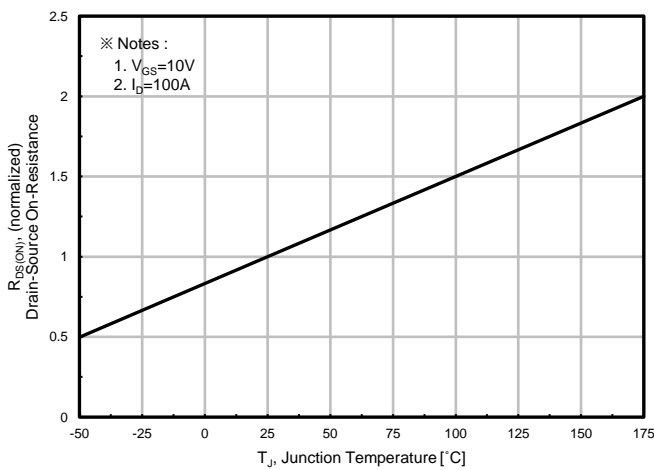

Fig. 3. On-Resistance vs. Junction Temperature

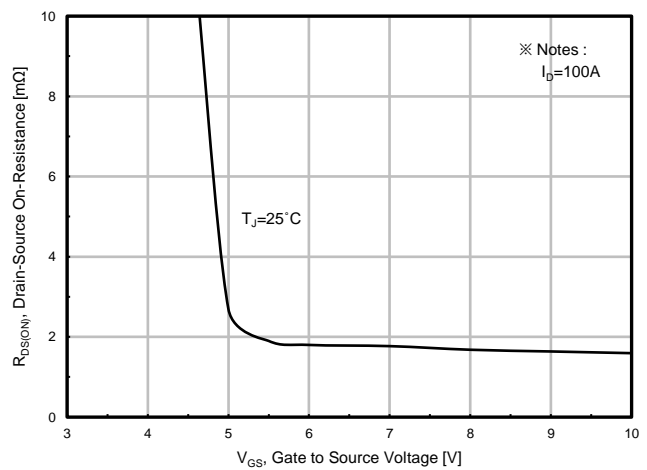

Fig. 4. On-Resistance vs. Gate to Source Voltage

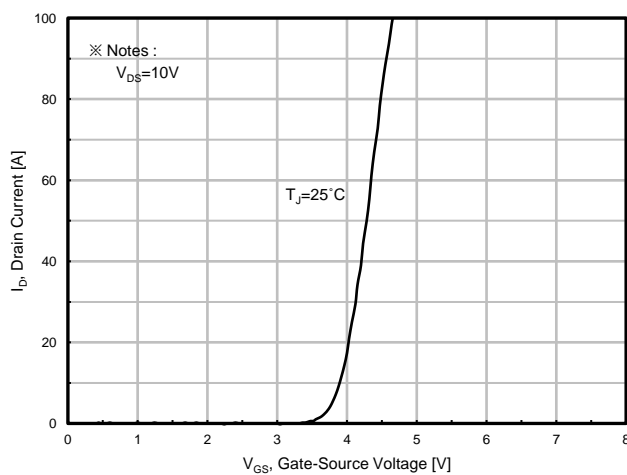

Fig. 5. Transfer Characteristics

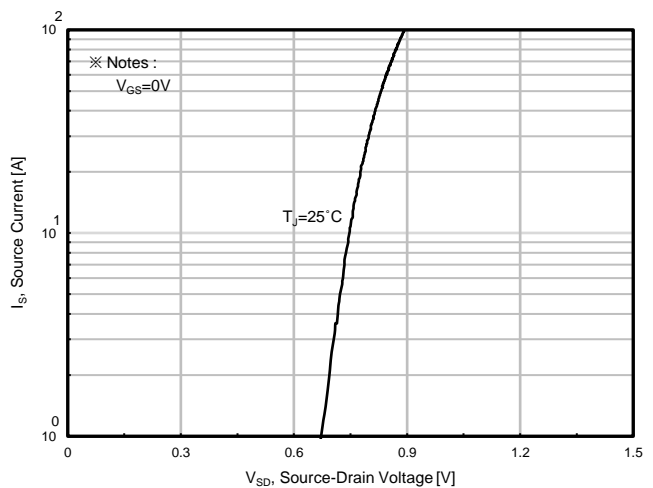

Fig. 6. Body Diode Forward Voltage Variation with Source Current and Temperature

Electrical characteristics diagrams

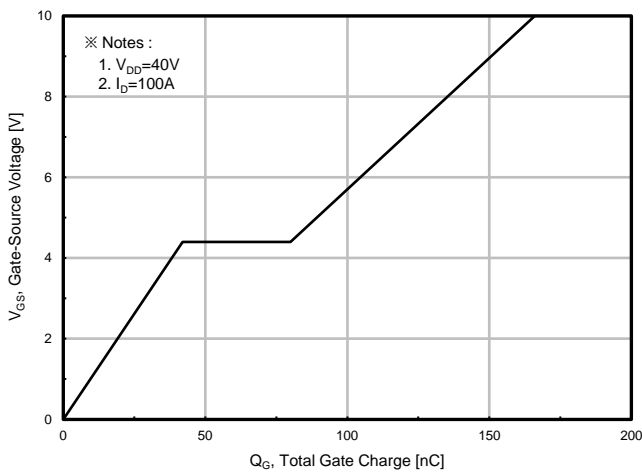

Fig. 7. Gate Charge

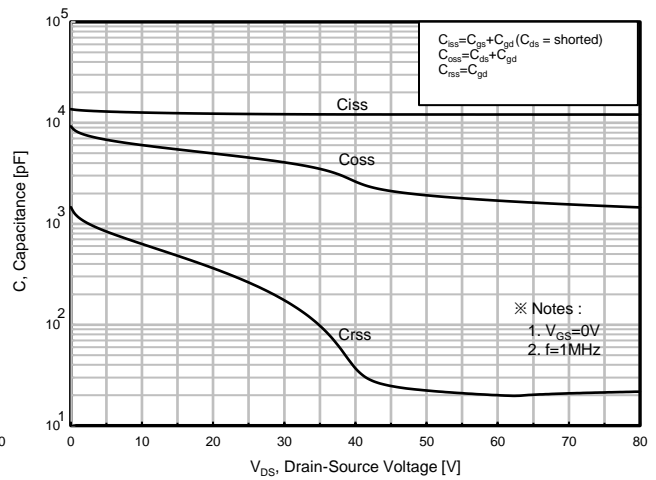

Fig. 8. Capacitances

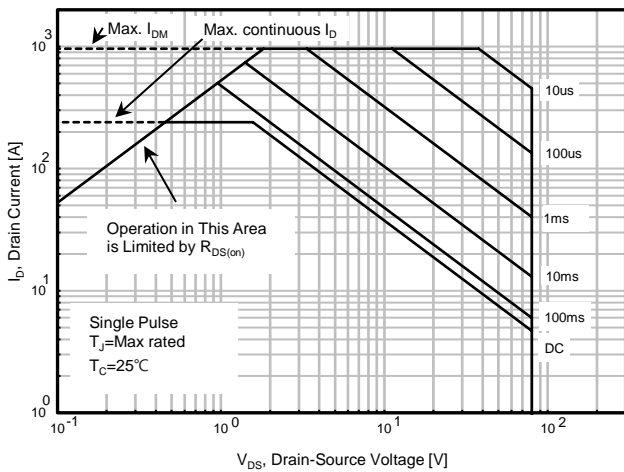

Fig. 9. Safe Operating Area

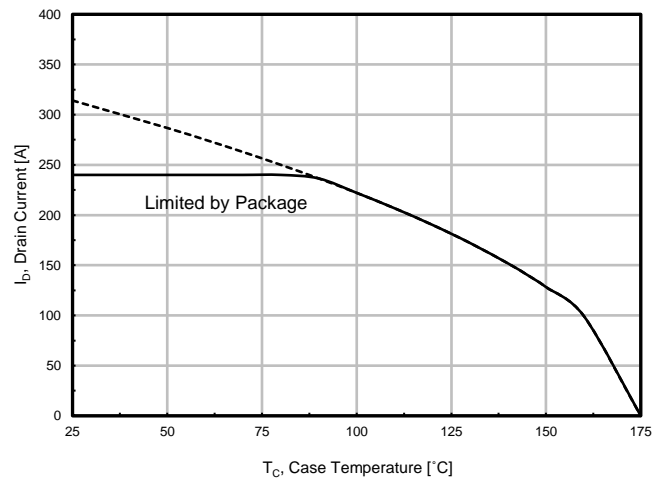

Fig. 10. Maximum Drain Current vs. Case Temperature

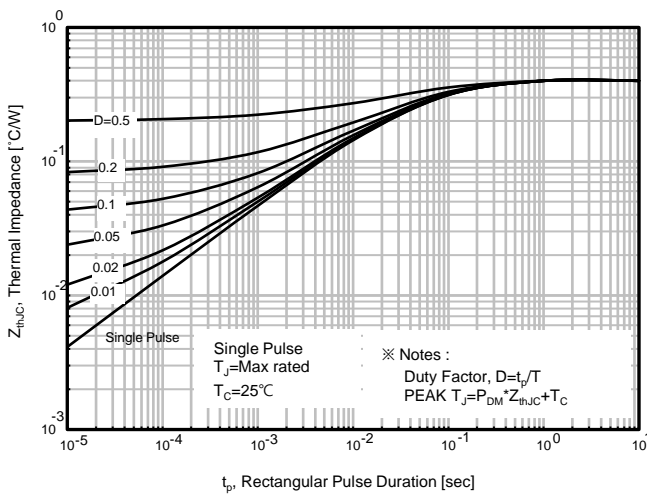
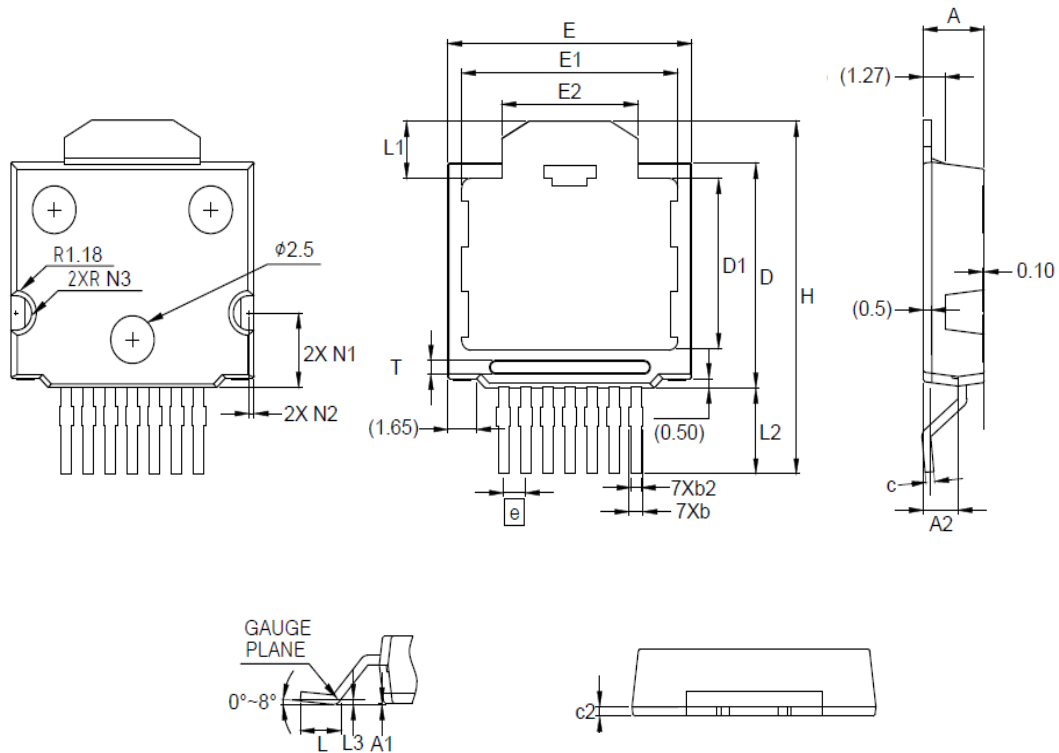

Fig. 11. Transient Thermal Impedance

Package information

M2PAK-7P



Symbol	Dimension (mm)		
	Min	Nom	Max
A	3,40	-	3,60
A1	0,00	-	0,25
A2	1,80	-	2,20
b	0,50	-	0,70
b2	0,50	-	1,00
c	0,40	-	0,60
c2	0,40	-	0,60
D	11,70	-	11,90
D1	8,90	-	9,10
E	13,90	-	14,10
E1	12,30	-	12,50
E2	7,75	-	7,85
T	0,60	-	0,70
e	BSC 1,27		
H	18,00	-	19,00
L	2,22	-	2,42
L1	2,90	-	3,10
L2	4,35	-	4,65
L3	BSC 0,25		
N1	3,80	-	4,00
N2	0,25	-	0,35
N3	0,80	-	1,00

Note : Package body size, length and width do not include mold flash, protrusions and gate burrs.

DISCLAIMER :

The Products are not designed for use in hostile environments, including, without limitation, aircraft, nuclear power generation, medical appliances, and devices or systems in which malfunction of any Product can reasonably be expected to result in a personal injury. Seller's customers using or selling Seller's products for use in such applications do so at their own risk and agree to fully defend and indemnify Seller.

Magnachip reserves the right to change the specifications and circuitry without notice at any time. Magnachip does not consider responsibility for use of any circuitry other than circuitry entirely included in a Magnachip product.  Magnachip is registered trademarks of Magnachip Semiconductor Ltd.