

# MDU04N010VRH

## Single N-channel Trench MOSFET 40V, 100A, 1.0mΩ

### General Description

The MDU04N010VRH uses advanced Magnachip’s MOSFET Technology, which provides high performance in on-state resistance, fast switching performance and excellent quality. MDU04N010VRH is suitable device for Synchronous Rectification for Server and general purpose applications.

### Features

- $V_{DS} = 40V$
- $I_D = 100A @ V_{GS} = 10V$
- Very low on-resistance  $R_{DS(ON)} < 1.0m\Omega @ V_{GS} = 10V$
- 100% UIL Tested
- 100% Rg Tested

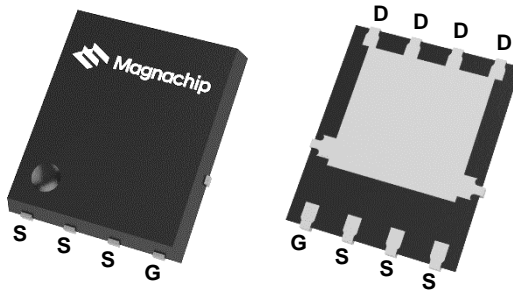

PDFN56

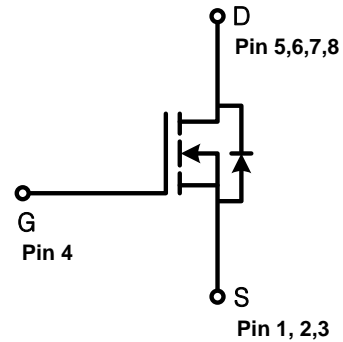

### Absolute Maximum Ratings (Ta = 25°C)

Characteristics		Symbol	Rating	Unit
Drain-Source Voltage		$V_{DSS}$	40	V
Gate-Source Voltage		$V_{GSS}$	±20	V
Continuous Drain Current <sup>(1)</sup>	$T_C=25^\circ C$	$I_D$	100.0	A
	$T_C=100^\circ C$		152.7	
	$T_A=25^\circ C^{(3)}$		39.0 <sup>(3)</sup>	
Pulsed Drain Current		$I_{DM}$	400.0	
Power Dissipation	$T_C=25^\circ C$	$P_D$	96.2	W
	$T_C=100^\circ C$		38.5	
	$T_A=25^\circ C^{(3)}$		2.5 <sup>(3)</sup>	
Single Pulse Avalanche Energy <sup>(2)</sup>		$E_{AS}$	450	mJ
Junction and Storage Temperature Range		$T_J, T_{stg}$	-55~150	°C

### Thermal Characteristics

Characteristics	Symbol	Rating	Unit
Thermal Resistance, Junction-to-Ambient <sup>(1)</sup>	$R_{\theta JA}$	50	°C/W
Thermal Resistance, Junction-to-Case	$R_{\theta JC}$	1.3	

## Ordering Information

Part Number	Temp. Range	Package	Packing	RoHS Status
MDU04N010VRH	-55~150°C	PDFN56	Tape & Reel	Halogen Free

## Electrical Characteristics (T<sub>J</sub> =25°C)

Characteristics	Symbol	Test Condition	Min	Typ	Max	Unit
<b>Static Characteristics</b>						
Drain-Source Breakdown Voltage	BV <sub>DSS</sub>	I <sub>D</sub> = 250μA, V <sub>GS</sub> = 0V	40	-	-	V
Gate Threshold Voltage	V <sub>GS(th)</sub>	V <sub>DS</sub> = V <sub>GS</sub> , I <sub>D</sub> = 250μA	1.0	-	2.0	
Drain Cut-Off Current	I <sub>DSS</sub>	V <sub>DS</sub> = 32V, V <sub>GS</sub> = 0V	-	-	1.0	μA
Gate Leakage Current	I <sub>GSS</sub>	V <sub>GS</sub> = ±20V, V <sub>DS</sub> = 0V	-	-	±0.1	
Drain-Source ON Resistance	R <sub>DS(ON)</sub>	V <sub>GS</sub> = 10V, I <sub>D</sub> = 50A	-	0.8	1.0	mΩ
Forward Transconductance	g <sub>fs</sub>	V <sub>DS</sub> = 10V, I <sub>D</sub> = 50A	-	185	-	S
<b>Dynamic Characteristics</b>						
Total Gate Charge	Q <sub>g(10.0V)</sub>	V <sub>DS</sub> = 20V, I <sub>D</sub> = 50A, V <sub>GS</sub> = 10V	-	103.5	-	nC
Gate-Source Charge	Q <sub>gs</sub>		-	18.5	-	
Gate-Drain Charge	Q <sub>gd</sub>		-	13.7	-	
Input Capacitance	C <sub>iss</sub>	V <sub>DS</sub> = 20V, V <sub>GS</sub> = 0V, f = 1.0MHz	-	6,892	-	pF
Reverse Transfer Capacitance	C <sub>rss</sub>		-	147	-	
Output Capacitance	C <sub>oss</sub>		-	2,058	-	
Turn-On Delay Time	t <sub>d(on)</sub>	V <sub>GS</sub> = 10V, V <sub>DS</sub> = 20V, I <sub>D</sub> = 50A, R <sub>G</sub> = 3.0Ω	-	21.8	-	ns
Rise Time	t <sub>r</sub>		-	18.8	-	
Turn-Off Delay Time	t <sub>d(off)</sub>		-	96.3	-	
Fall Time	t <sub>f</sub>		-	44.1	-	
Gate Resistance	R <sub>g</sub>	f=1.0 MHz	-	1.0	-	Ω
<b>Drain-Source Body Diode Characteristics</b>						
Diode continuous forward current	I <sub>S</sub>	-	-	-	100	A
Diode pulse current	I <sub>S,pulse</sub>	pulsed; t <sub>p</sub> ≤ 10 μs	-	-	400	
Source-Drain Diode Forward Voltage	V <sub>SD</sub>	I <sub>S</sub> = 50A, V <sub>GS</sub> = 0V	-	0.80	1.20	V
Body Diode Reverse Recovery Time	t <sub>rr</sub>	I <sub>F</sub> = 50A, di/dt = 100A/μs	-	57.7	-	ns
Body Diode Reverse Recovery Charge	Q <sub>rr</sub>		-	105.4	-	nC

Note :

- Surface mounted FR-4 board by JEDEC (jesd51-7). Continuous current at T<sub>C</sub>=25°C is silicon limited
- E<sub>AS</sub> is tested at starting T<sub>J</sub> = 25°C, L = 1.0mH, I<sub>AS</sub> = 30.0A, V<sub>GS</sub> = 10V.
- T < 10sec.

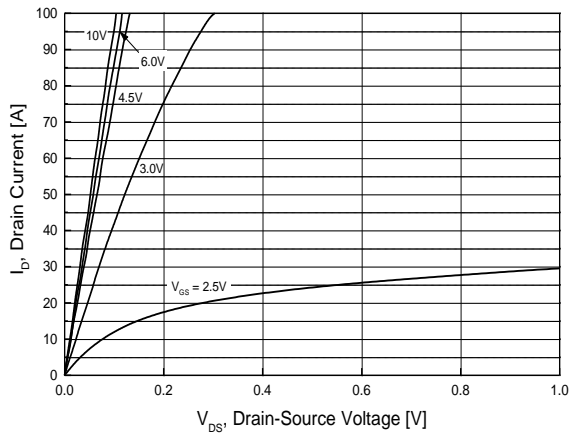

**Fig.1 On-Region Characteristics**

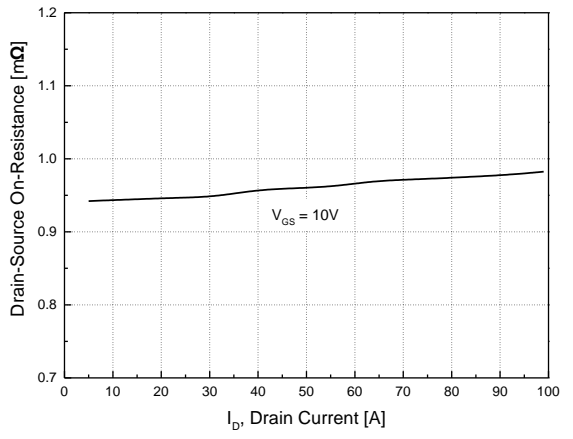

**Fig.2 On-Resistance Variation with Drain Current and Gate Voltage**

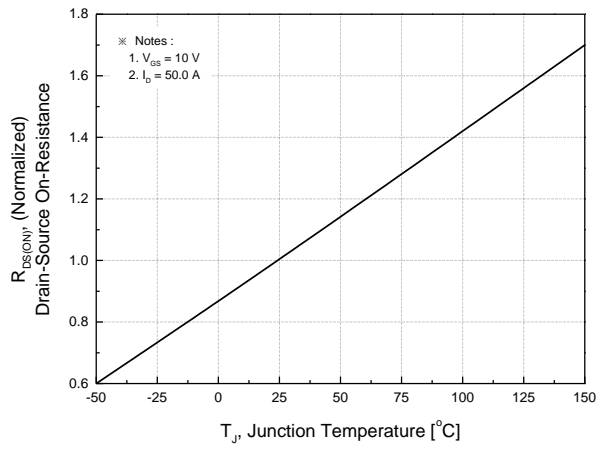

**Fig.3 On-Resistance Variation with Temperature**

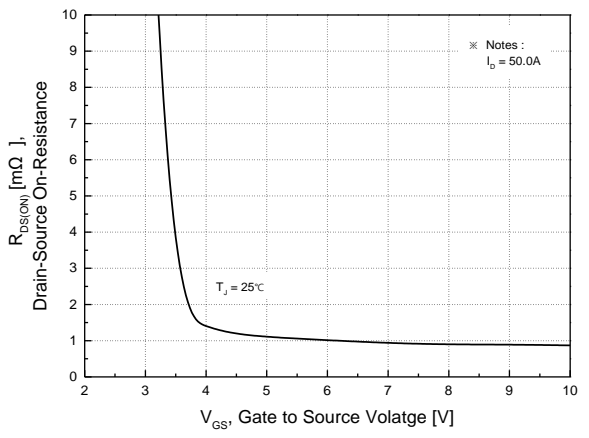

**Fig.4 On-Resistance Variation with Gate to Source Voltage**

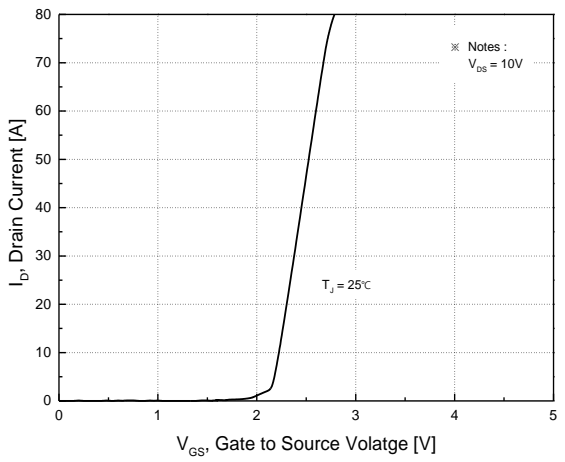

**Fig.5 Transfer Characteristics**

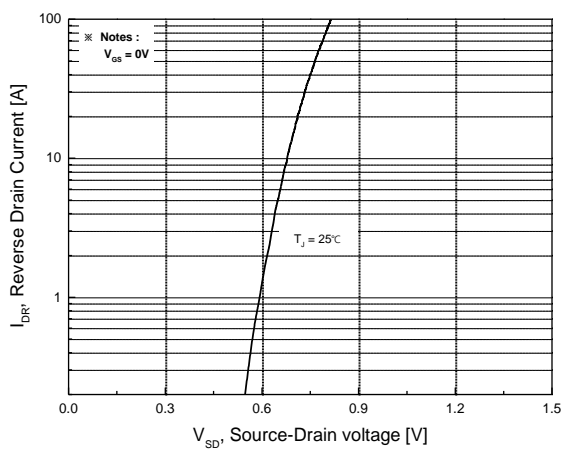

**Fig.6 Body Diode Forward Voltage Variation with Source Current and Temperature**

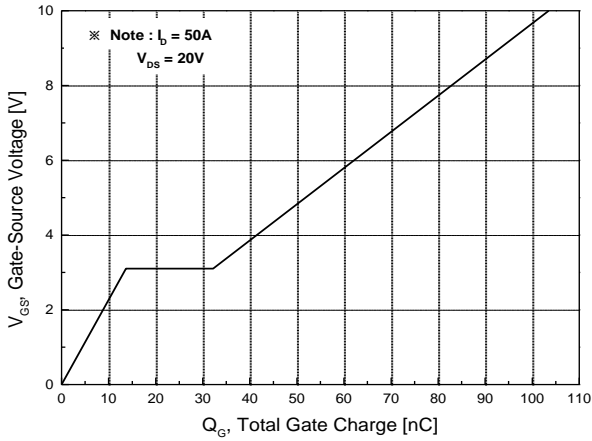

**Fig.7 Gate Charge Characteristics**

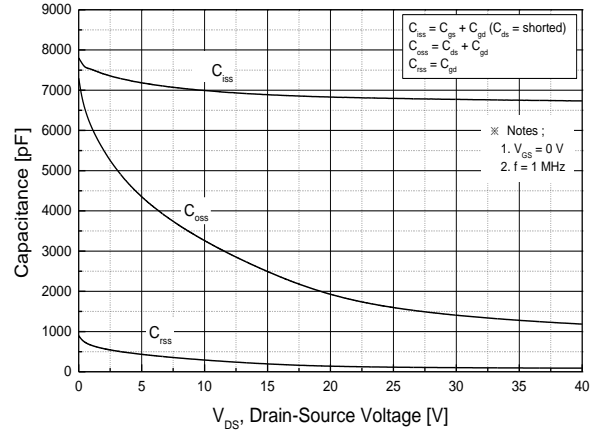

**Fig.8 Capacitance Characteristics**

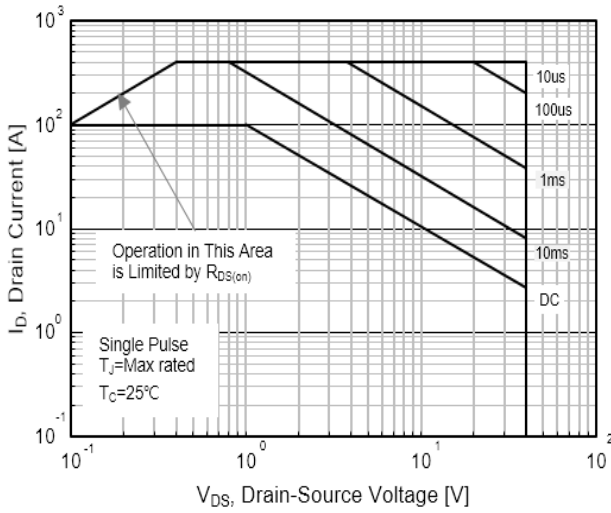

**Fig.9 Maximum Safe Operating Area**

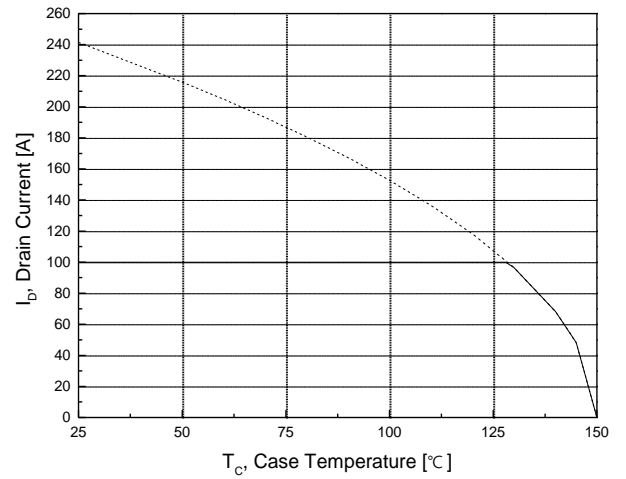

**Fig.10 Maximum Drain Current vs. Case Temperature**

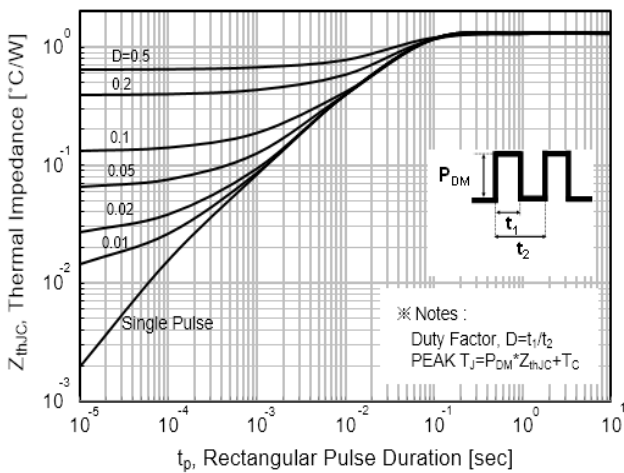
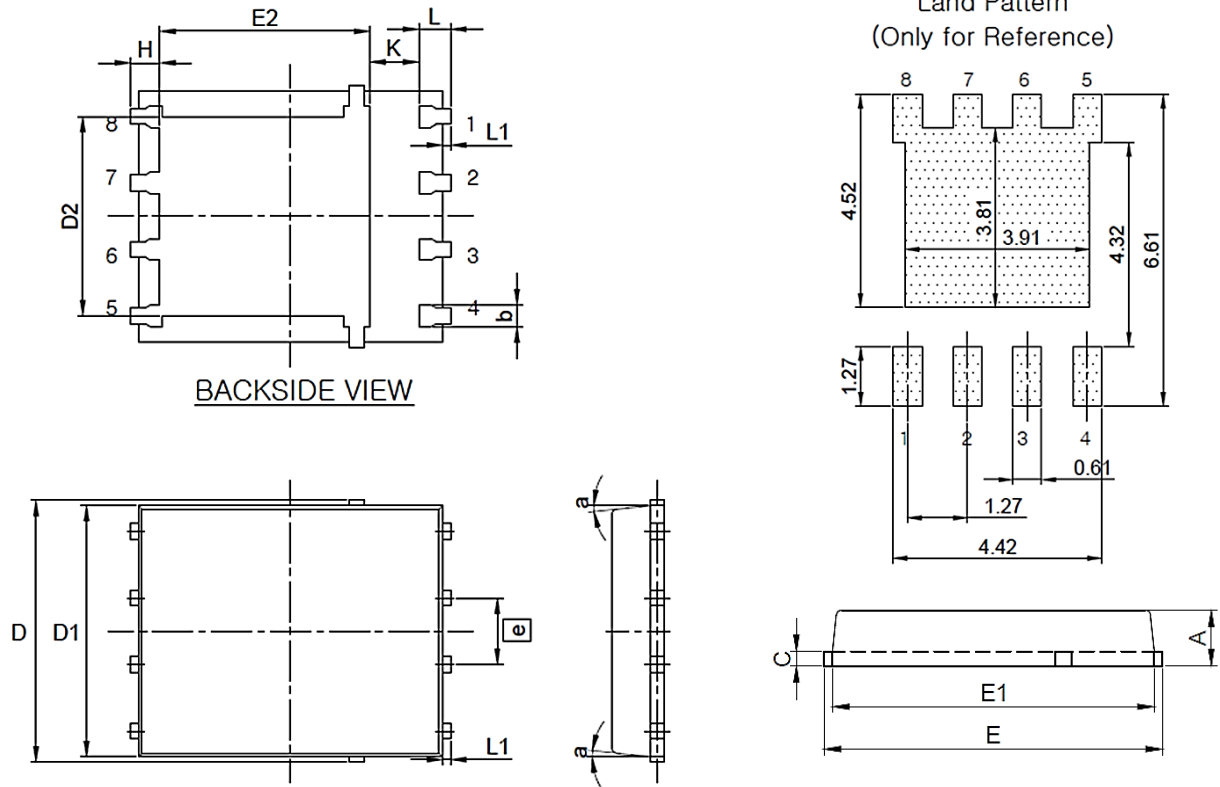

**Fig.11 Transient Thermal Response Curve**

## Package Dimension

### PDFN56 (5x6mm)

Dimensions are in millimeters, unless otherwise specified



Symbol	Dimension (mm)		
	Min	Nom	Max
A	0.90	–	1.10
b	0.33	–	0.51
C	0.20	–	0.34
D	4.50	–	5.30
D1	4.50	–	5.10
D2	–	–	4.22
E	5.90	–	6.30
E1	5.50	–	6.10
E2	–	–	4.30
e	1.27 BSC		
H	0.41	–	0.71
K	0.20	–	–
L	0.51	–	0.71
L1	0.06	–	0.20
a	0°	–	12°

Note : Package body size, length and width do not include mold flash, protrusions and gate burrs.

**DISCLAIMER:**

The Products are not designed for use in hostile environments, including, without limitation, aircraft, nuclear power generation, medical appliances, and devices or systems in which malfunction of any Product can reasonably be expected to result in a personal injury. Seller's customers using or selling Seller's products for use in such applications do so at their own risk and agree to fully defend and indemnify Seller.

Magnachip reserves the right to change the specifications and circuitry without notice at any time. Magnachip does not consider responsibility for use of any circuitry other than circuitry entirely included in a Magnachip product.  Magnachip is a registered trademark of Magnachip Semiconductor Ltd.