



# MDP08N032TH

Single N-channel Trench MOSFET 80V 3.23mΩ 120A

## General description

The MDP08N032TH uses advanced Magnachip's MV MOSFET Technology, which provides high performance in on-state resistance, fast switching performance, and excellent quality.

MDP08N032TH is suitable device for Motor Drive applications and general purpose applications.

TO-220



Top View

Bottom View

## Features and benefits

- Magnachip's MOSFET Technology
- Very low on-resistance  $R_{DS(on)}$
- 100% Avalanche / Rg Tested

## Applications

- Specifically for E-Bike applications
- Switching Applications
- Drives

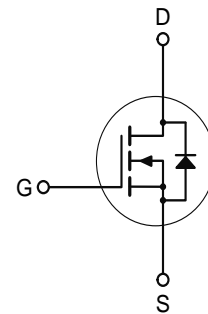

## Key performance parameters

$V_{DS}$	80	V
$R_{DS(on), max}$	0.00323	$\Omega$
$I_D$	120	A
$Q_G$	106	nC
Junction temperature, $_{max}$	175	$^{\circ}C$



## Ordering information

Type / Ordering Code	Package	Marking	Packing	RoHS Status
MDP08N032TH	TO-220	08N032	Tube	Halogen Free

<http://www.magnachip.com/powersolutions>



**Maximum ratings**, at  $T_A = 25^\circ\text{C}$ , unless otherwise specified

Parameter		Symbol	Rating	Unit
Drain-source Voltage		$V_{DS}$	80	V
Gate-source Voltage		$V_{GS}$	$\pm 20$	V
Drain current	$T_C=25^\circ\text{C}$ Silicon Limited	$I_D$	188	A
	$T_C=25^\circ\text{C}$ Package Limited		120	A
	$T_C=100^\circ\text{C}$ Silicon Limited		133	A
<sup>1)</sup> Pulsed drain current	$T_C=25^\circ\text{C}$	$I_{DM}$	480	A
Total power dissipation	$T_C=25^\circ\text{C}$	$P_{tot}$	231	W
	$T_C=100^\circ\text{C}$		115	W
<sup>2)</sup> Avalanche energy, single pulse		$E_{AS}$	365	mJ
Operating and storage temperature		$T_j, T_{stg}$	- 55 ~ 175	$^\circ\text{C}$

**Thermal characteristics**

Parameter		Symbol	Rating	Unit
Thermal resistance, junction - case		$R_{\theta JC}$	0.65	$^\circ\text{C}/\text{W}$
<sup>3)</sup> Thermal resistance, junction - ambient		$R_{\theta JA}$	62.5	$^\circ\text{C}/\text{W}$

**Notes**

- Pulse width limited by  $T_{jmax}$
- EAS is tested at starting  $T_j = 25^\circ\text{C}$ ,  $L = 1.0\text{mH}$ ,  $I_{AS} = 27\text{A}$ ,  $V_{DD} = 50\text{V}$ ,  $V_{GS} = 10\text{V}$
- Surface mounted FR-4 board by JEDEC (jesd51-7)

Electrical Characteristics ( $T_J = 25^\circ\text{C}$ )

## Static characteristics

Parameter	Symbol	Min.	Typ.	Max.	Unit	Conditions / Note
Drain-source breakdown voltage	$V_{(BR)DSS}$	80	-	-	V	$V_{GS}=0\text{ V}$ , $I_D=250\ \mu\text{A}$
Gate threshold voltage	$V_{GS(th)}$	2.25	3.0	3.75	V	$V_{DS}=V_{GS}$ , $I_D=250\ \mu\text{A}$
Zero gate voltage drain current	$I_{DSS}$	-	-	1	$\mu\text{A}$	$V_{DS}=80\text{ V}$ , $V_{GS}=0\text{ V}$
Gate-source leakage current	$I_{GSS}$	-	-	$\pm 100$	nA	$V_{GS}=\pm 20\text{ V}$ , $V_{DS}=0\text{ V}$
Drain-source on-state resistance	$R_{DS(on)}$	-	2.70	3.23	m $\Omega$	$V_{GS}=10\text{ V}$ , $I_D=60\text{ A}$
Gate resistance	$R_G$	-	3.0	-	$\Omega$	$f=1\text{MHz}$
Transconductance	$g_{fs}$	-	104	-	S	$V_{DS}=10\text{ V}$ , $I_D=60\text{ A}$

## Dynamic characteristics

Parameter	Symbol	Min.	Typ.	Max.	Unit	Conditions / Note
Input capacitance	$C_{iss}$	-	7077	-	pF	$V_{DS}=0\text{ V}$ , $V_{GS}=40\text{ V}$ , $f=1\text{ MHz}$
Output capacitance	$C_{oss}$	-	1408	-	pF	$V_{GS}=0\text{ V}$ , $V_{DS}=40\text{ V}$ , $f=1\text{ MHz}$
Reverse transfer capacitance	$C_{rss}$	-	40	-	pF	$V_{GS}=0\text{ V}$ , $V_{DS}=40\text{ V}$ , $f=1\text{ MHz}$
Turn-on delay time	$t_{d(on)}$	-	28	-	ns	$V_{DD}=40\text{ V}$ , $V_{GS}=10\text{ V}$ , $I_D=60\text{ A}$ , $R_{G,ext}=3\Omega$
Rise time	$t_r$	-	17	-	ns	$V_{DD}=40\text{ V}$ , $V_{GS}=10\text{ V}$ , $I_D=60\text{ A}$ , $R_{G,ext}=3\Omega$
Turn-off delay time	$t_{d(off)}$	-	81	-	ns	$V_{DD}=40\text{ V}$ , $V_{GS}=10\text{ V}$ , $I_D=60\text{ A}$ , $R_{G,ext}=3\Omega$
Fall time	$t_f$	-	30	-	ns	$V_{DD}=40\text{ V}$ , $V_{GS}=10\text{ V}$ , $I_D=60\text{ A}$ , $R_{G,ext}=3\Omega$

## Gate charge characteristics

Parameter	Symbol	Min.	Typ.	Max.	Unit	Conditions / Note
Gate to source charge	$Q_{gs}$	-	30	-	nC	$V_{DD}=40\text{ V}$ , $I_D=60\text{ A}$ , $V_{GS}=0\text{ to }10\text{ V}$
Gate charge at threshold	$Q_{gs(th)}$	-	22	-	nC	$V_{DD}=40\text{ V}$ , $I_D=60\text{ A}$ , $V_{GS}=0\text{ to }10\text{ V}$
Gate to drain charge	$Q_{gd}$	-	24	-	nC	$V_{DD}=40\text{ V}$ , $I_D=60\text{ A}$ , $V_{GS}=0\text{ to }10\text{ V}$
Switching charge	$Q_{sw}$	-	32	-	nC	$V_{DD}=40\text{ V}$ , $I_D=60\text{ A}$ , $V_{GS}=0\text{ to }10\text{ V}$
Gate charge total	$Q_g$	-	106	-	nC	$V_{DD}=40\text{ V}$ , $I_D=60\text{ A}$ , $V_{GS}=0\text{ to }10\text{ V}$
Gate plateau voltage	$V_{plateau}$	-	5.1	-	V	$V_{DD}=40\text{ V}$ , $I_D=60\text{ A}$ , $V_{GS}=0\text{ to }10\text{ V}$

## Source-drain diode

Parameter	Symbol	Min.	Typ.	Max.	Unit	Conditions / Note
Diode continuous forward current	$I_S$	-	-	120	A	-
Diode pulse current	$I_{S,pulse}$	-	-	480	A	pulsed; $t_p \leq 10\ \mu\text{s}$
Diode forward voltage	$V_{SD}$	-	0.9	1.2	V	$V_{GS}=0\text{ V}$ , $I_F=60\text{ A}$
Reverse recovery time	$t_{rr}$	-	111	-	ns	$I_F=60\text{ A}$ , $dI_F/dt=100\text{ A}/\mu\text{s}$
Reverse recovery charge	$Q_{rr}$	-	304	-	nC	$I_F=60\text{ A}$ , $dI_F/dt=100\text{ A}/\mu\text{s}$

Electrical characteristics diagrams

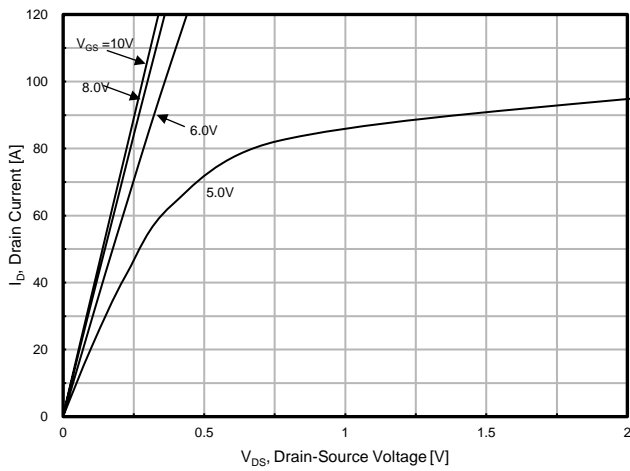

Fig. 1. Output Characteristics

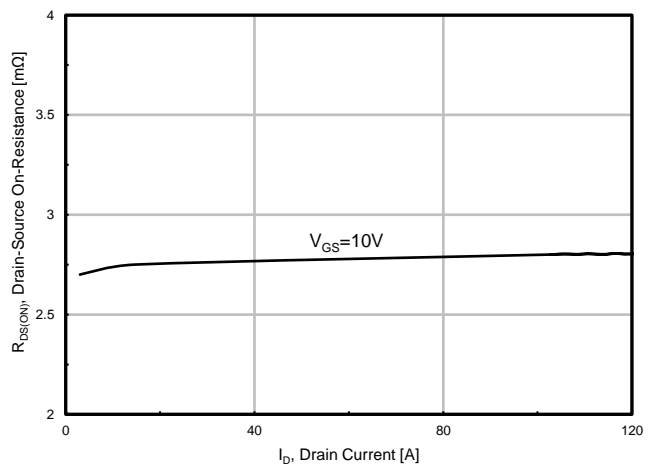

Fig. 2. Static On-Resistance Variation

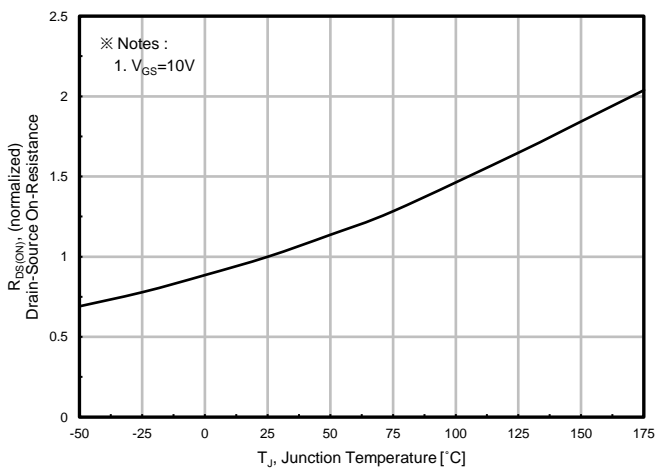

Fig. 3. On-Resistance vs. Junction Temperature

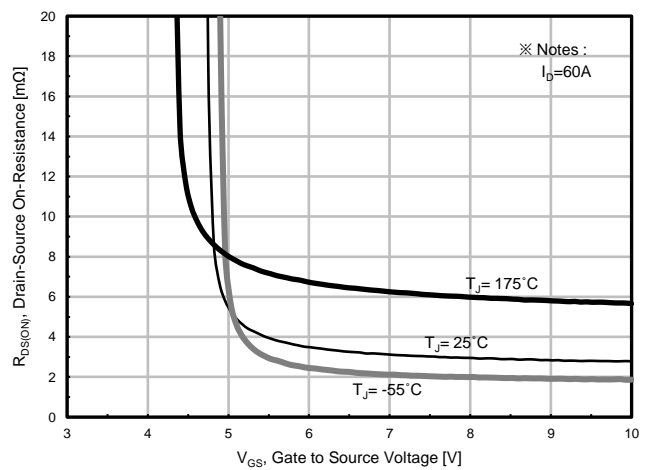

Fig. 4. On-Resistance vs. Gate to Source Voltage

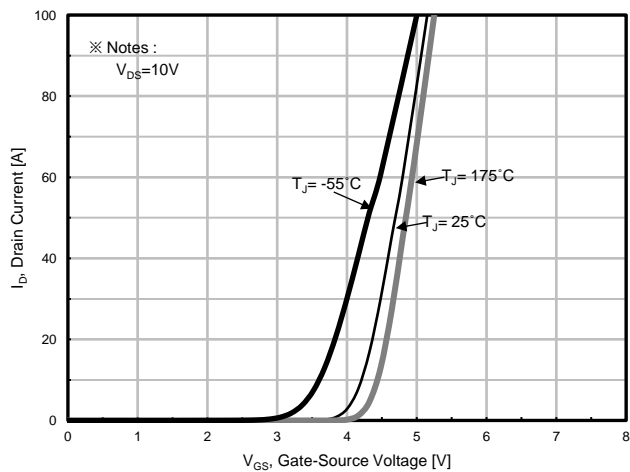

Fig. 5. Transfer Characteristics

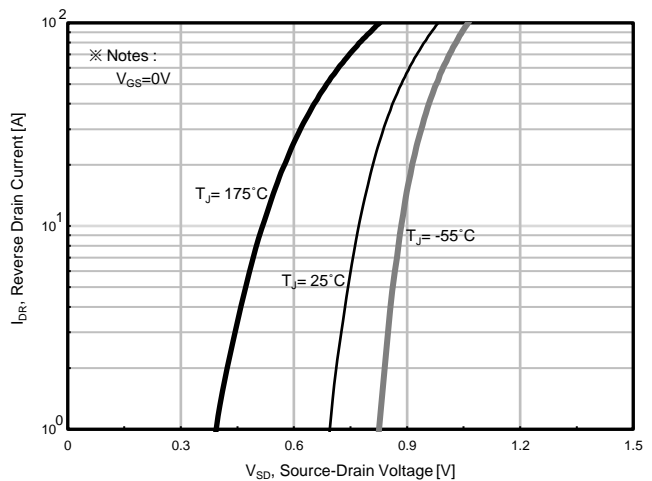

Fig. 6. Body Diode Forward Voltage Variation with Source Current and Temperature

Electrical characteristics diagrams

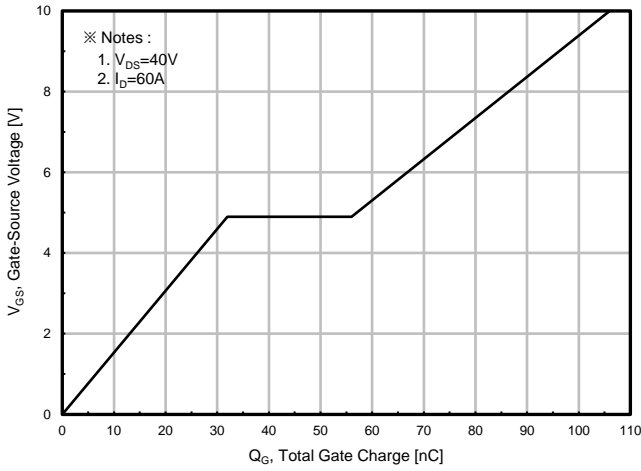

Fig. 7. Gate Charge

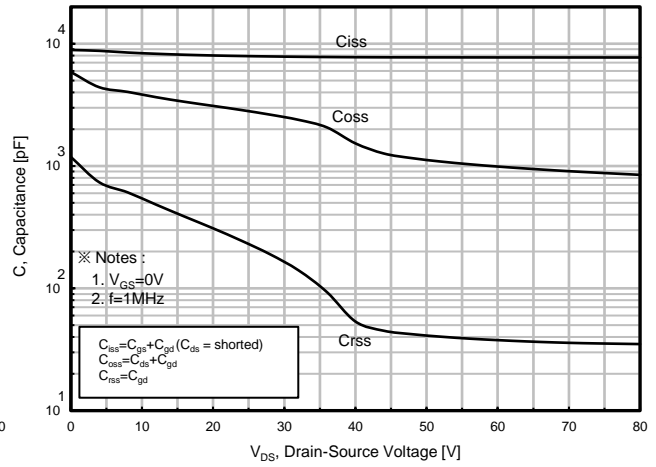

Fig. 8. Capacitance

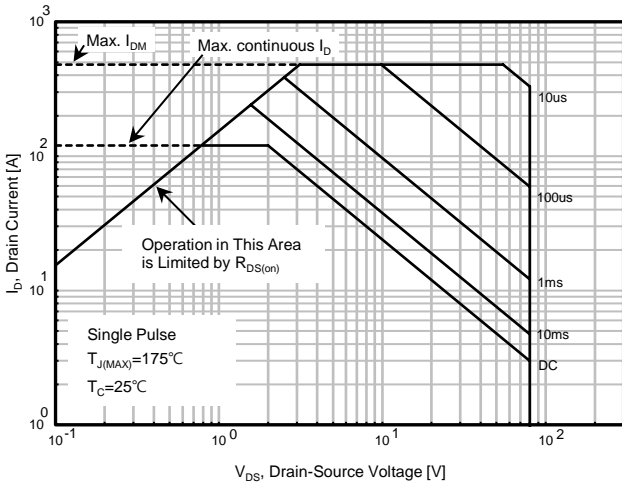

Fig. 9. Safe Operating Area

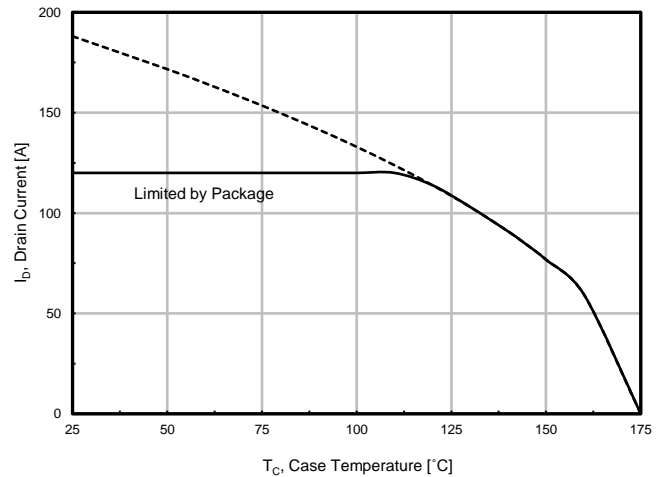

Fig. 10. Maximum Drain Current vs. Case Temperature

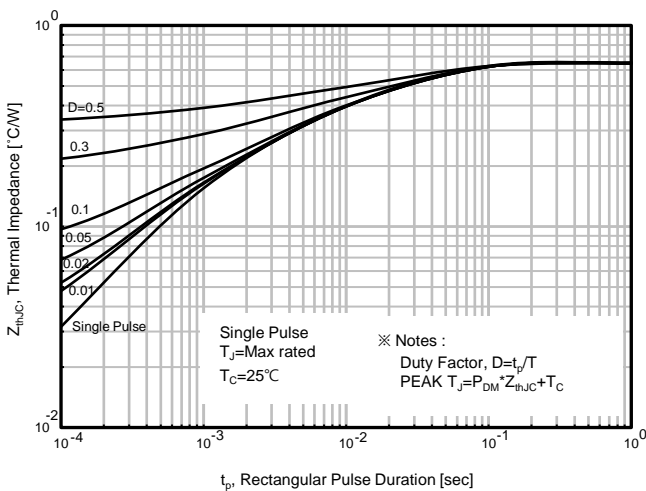
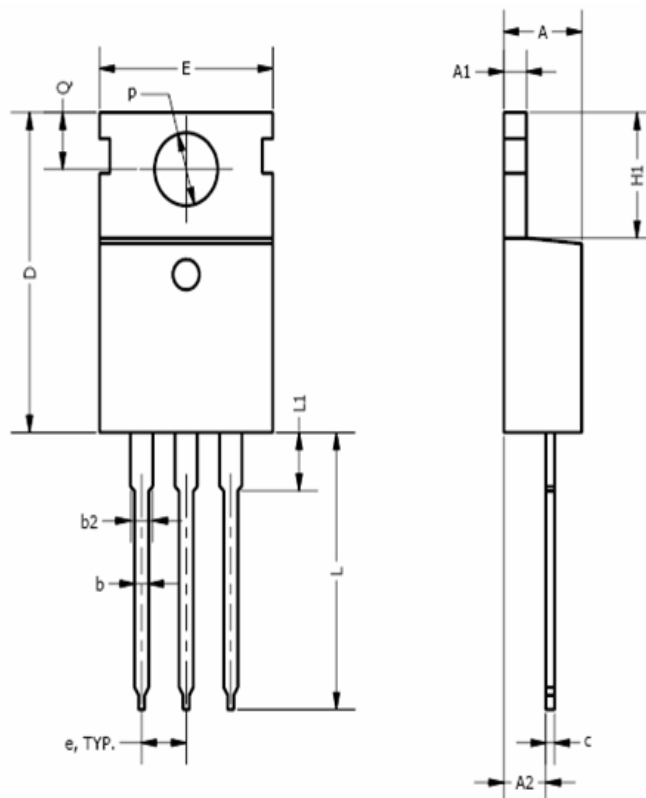

Fig. 11. Transient Thermal Impedance

# Package information

TO-220



Symbol	Min	Nom	Max
A	3.56		4.83
A1	0.50		1.40
A2	2.03		2.92
b	0.38	0.69	1.02
b2	1.14	1.45	1.78
c	0.36		0.61
D	14.22		16.51
e	2.54 TYP		
E	9.65		10.67
H1	5.84		6.86
L	12.70		14.73
L1			6.35
$\phi P$	3.53		4.09
Q	2.54		3.43

Note : Package body size, length and width do not include mold flash, protrusions and gate burrs.

**DISCLAIMER :**

The Products are not designed for use in hostile environments, including, without limitation, aircraft, nuclear power generation, medical appliances, and devices or systems in which malfunction of any Product can reasonably be expected to result in a personal injury. Seller's customers using or selling Seller's products for use in such applications do so at their own risk and agree to fully defend and indemnify Seller.

Magnachip reserves the right to change the specifications and circuitry without notice at any time. Magnachip does not consider responsibility for use of any circuitry other than circuitry entirely included in a Magnachip product.  Magnachip is registered trademarks of Magnachip Semiconductor Ltd.