

### General Description

The MDES08N019RH uses advanced Magnachip's MV MOSFET Technology, which provides high performance in on-state resistance, fast switching performance, and excellent quality.

MDES08N019RH is suitable device for Motor Drive applications and general purpose applications.

### Features

- $V_{DS} = 80V$
- $I_D = 180A @ V_{GS} = 10V$
- Very low on-resistance  $R_{DS(ON)} < 1.9 m\Omega @ V_{GS} = 10V$
- 100% UIL Tested
- 100%  $R_g$  Tested
- 175°C operating temperature

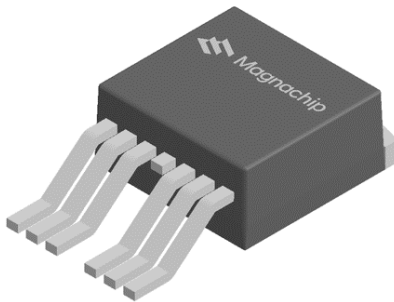

**TO-263-7P**

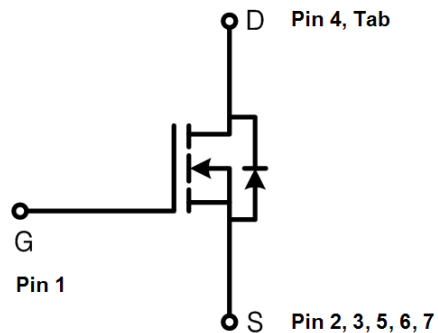

### Absolute Maximum Ratings ( $T_J = 25^\circ C$ )

Characteristics		Symbol	Rating	Unit
Drain-Source Voltage		$V_{DSS}$	80	V
Gate-Source Voltage		$V_{GSS}$	$\pm 20$	V
Continuous Drain Current <sup>(1)</sup>	$T_C = 25^\circ C$ (Silicon Limited)	$I_D$	280	A
	$T_C = 25^\circ C$ (Package Limited)		180	
	$T_C = 100^\circ C$ (Silicon Limited)		198	
Pulsed Drain Current <sup>(2)</sup>		$I_{DM}$	720	
Power Dissipation	$T_C = 25^\circ C$	$P_D$	300	W
	$T_C = 100^\circ C$		150	
Single Pulse Avalanche Energy <sup>(3)</sup>		$E_{AS}$	613	mJ
Junction and Storage Temperature Range		$T_J, T_{stg}$	-55~175	$^\circ C$

### Thermal Characteristics

Characteristics	Symbol	Rating	Unit
Thermal Resistance, Junction-to-Ambient <sup>(1)</sup>	$R_{thJA}$	60	$^\circ C/W$
Thermal Resistance, Junction-to-Case	$R_{thJC}$	0.5	

## Ordering Information

Part Number	Temp. Range	Package	Packing	RoHS Status
MDES08N019RH	-55~175°C	TO-263-7P	Tape & Reel	Halogen Free

## Electrical Characteristics (T<sub>J</sub> = 25°C)

Characteristics	Symbol	Test Condition	Min.	Typ.	Max.	Unit
<b>Static Characteristics</b>						
Drain-Source Breakdown Voltage	BV <sub>DSS</sub>	V <sub>GS</sub> = 0V, I <sub>D</sub> = 250μA	80	-	-	V
Gate Threshold Voltage	V <sub>GS(th)</sub>	V <sub>DS</sub> = V <sub>GS</sub> , I <sub>D</sub> = 250μA	2.4		3.8	
Drain Cut-Off Current	I <sub>DSS</sub>	V <sub>DS</sub> = 80V, V <sub>GS</sub> = 0V	-	-	1	μA
Gate Leakage Current	I <sub>GSS</sub>	V <sub>GS</sub> = ±20V, V <sub>DS</sub> = 0V	-	-	±100	nA
Drain-Source ON Resistance	R <sub>DS(on)</sub>	V <sub>GS</sub> = 10V, I <sub>D</sub> = 100A	-	1.6	1.9	mΩ
		V <sub>GS</sub> = 6.0V, I <sub>D</sub> = 50A	-	2.0	3.3	
Forward Trans-conductance	g <sub>fs</sub>	V <sub>DS</sub> = 10V, I <sub>D</sub> = 100A	-	130	-	S
<b>Dynamic Characteristics</b>						
Total Gate Charge	Q <sub>g</sub>	V <sub>DS</sub> = 40V, V <sub>GS</sub> = 10V, I <sub>D</sub> = 100A	-	172	-	nC
Gate-Source Charge	Q <sub>gs</sub>		-	50	-	
Gate-Drain Charge	Q <sub>gd</sub>		-	42	-	
Input Capacitance	C <sub>iss</sub>	V <sub>DS</sub> = 40V, V <sub>GS</sub> = 0V, f = 1.0MHz	-	12,025	-	pF
Reverse Transfer Capacitance	C <sub>rss</sub>		-	40	-	
Output Capacitance	C <sub>oss</sub>		-	2,634	-	
Turn-On Delay Time	t <sub>d(on)</sub>	V <sub>DS</sub> = 40V, V <sub>GS</sub> = 10V, I <sub>D</sub> = 100A, R <sub>G</sub> = 3.0Ω	-	36	-	ns
Rise Time	t <sub>r</sub>		-	26	-	
Turn-Off Delay Time	t <sub>d(off)</sub>		-	119	-	
Fall Time	t <sub>f</sub>		-	66	-	
Gate Resistance	R <sub>g</sub>	f=1 MHz	-	3.2	-	Ω
<b>Drain-Source Body Diode Characteristics</b>						
Source-Drain Diode Forward Voltage	V <sub>SD</sub>	V <sub>GS</sub> = 0V, I <sub>S</sub> = 100A	-	1.0	1.2	V
Body Diode Reverse Recovery Time	t <sub>rr</sub>	I <sub>F</sub> = 100A, dI/dt = 100A/μs	-	134	-	ns
Body Diode Reverse Recovery Charge	Q <sub>rr</sub>		-	482	-	nC

Note :

- Surface mounted FR-4 board by JEDEC (jesd51-7)
- Pulse width limited by T<sub>jmax</sub>
- E<sub>AS</sub> is tested at starting T<sub>J</sub> = 25°C, L = 1.0mH, I<sub>AS</sub> = 35A, V<sub>DD</sub> = 50V, V<sub>GS</sub> = 10V

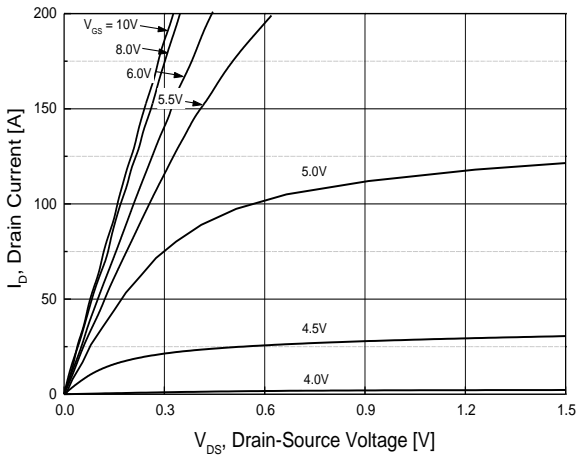

**Fig.1 On-Region Characteristics**

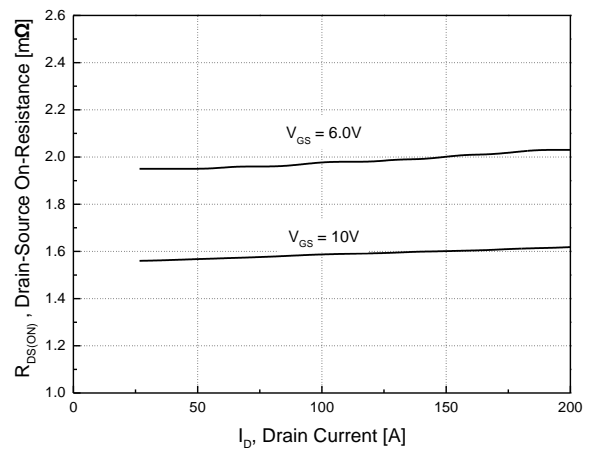

**Fig.2 On-Resistance Variation with Drain Current and Gate Voltage**

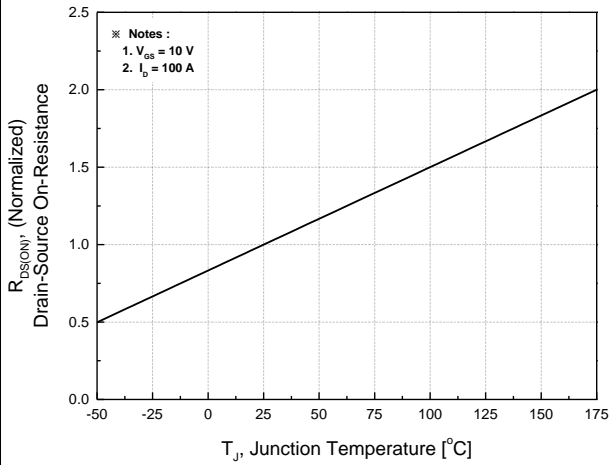

**Fig.3 On-Resistance Variation with Temperature**

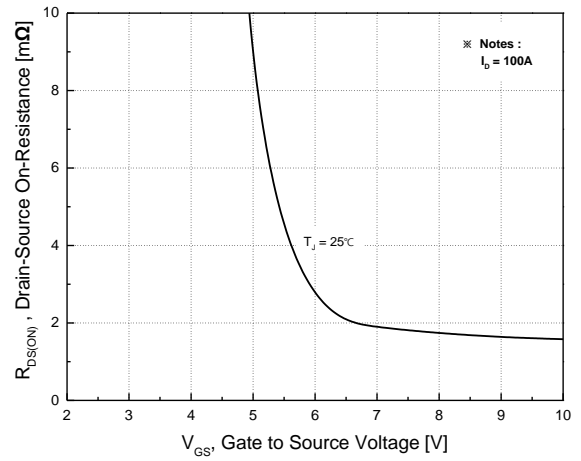

**Fig.4 On-Resistance Variation with Gate to Source Voltage**

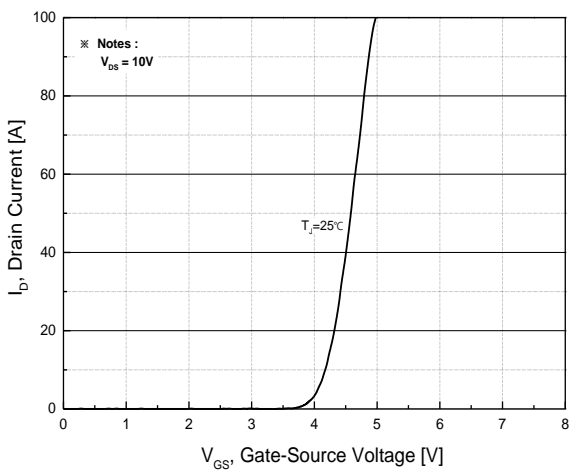

**Fig.5 Transfer Characteristics**

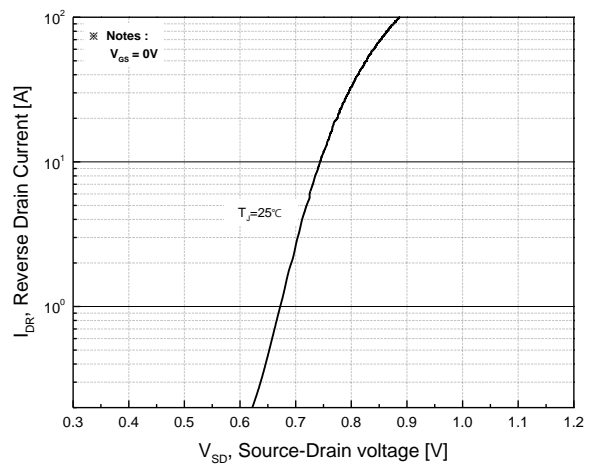

**Fig.6 Body Diode Forward Voltage Variation with Source Current and Temperature**

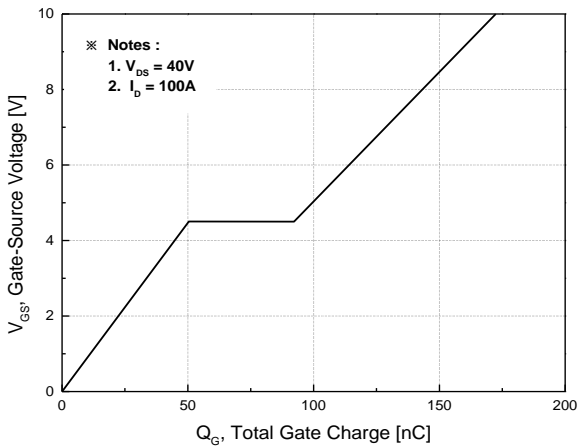

**Fig.7 Gate Charge Characteristics**

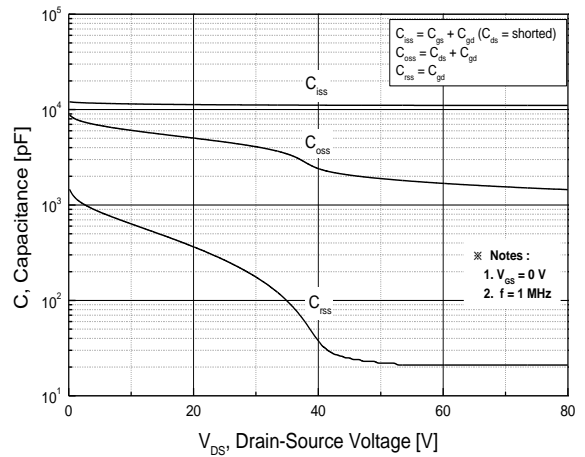

**Fig.8 Capacitance Characteristics**

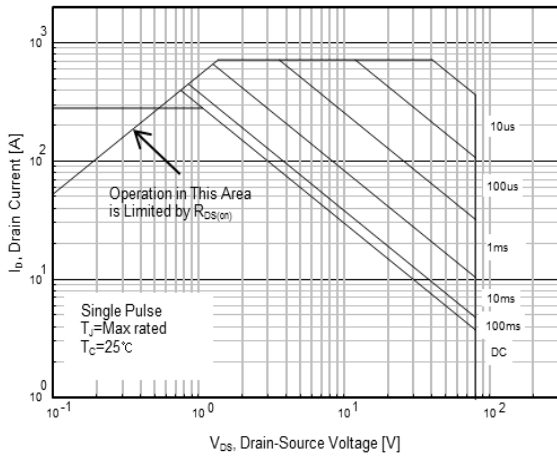

**Fig.9 Maximum Safe Operating Area**

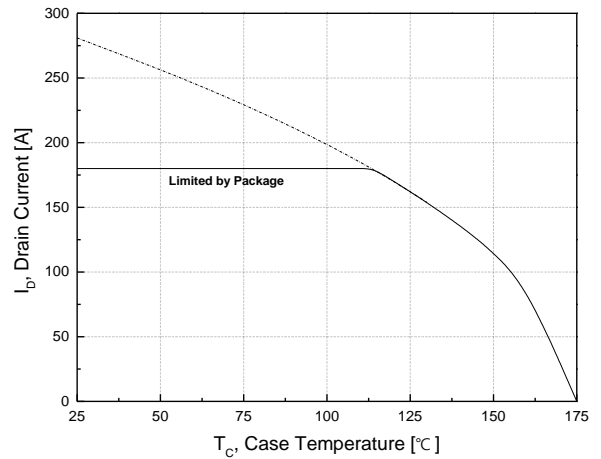

**Fig.10 Maximum Drain Current vs. Case Temperature**

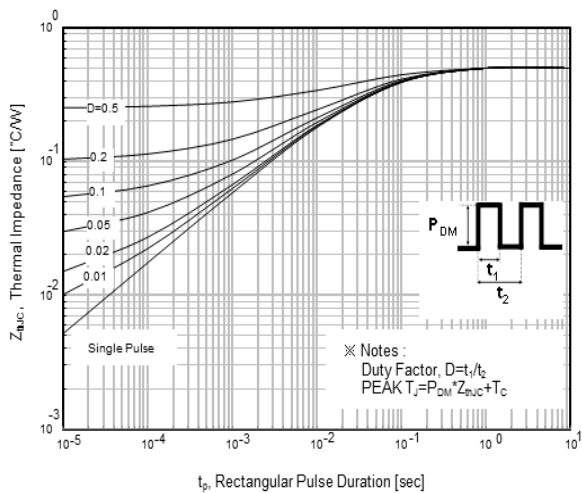
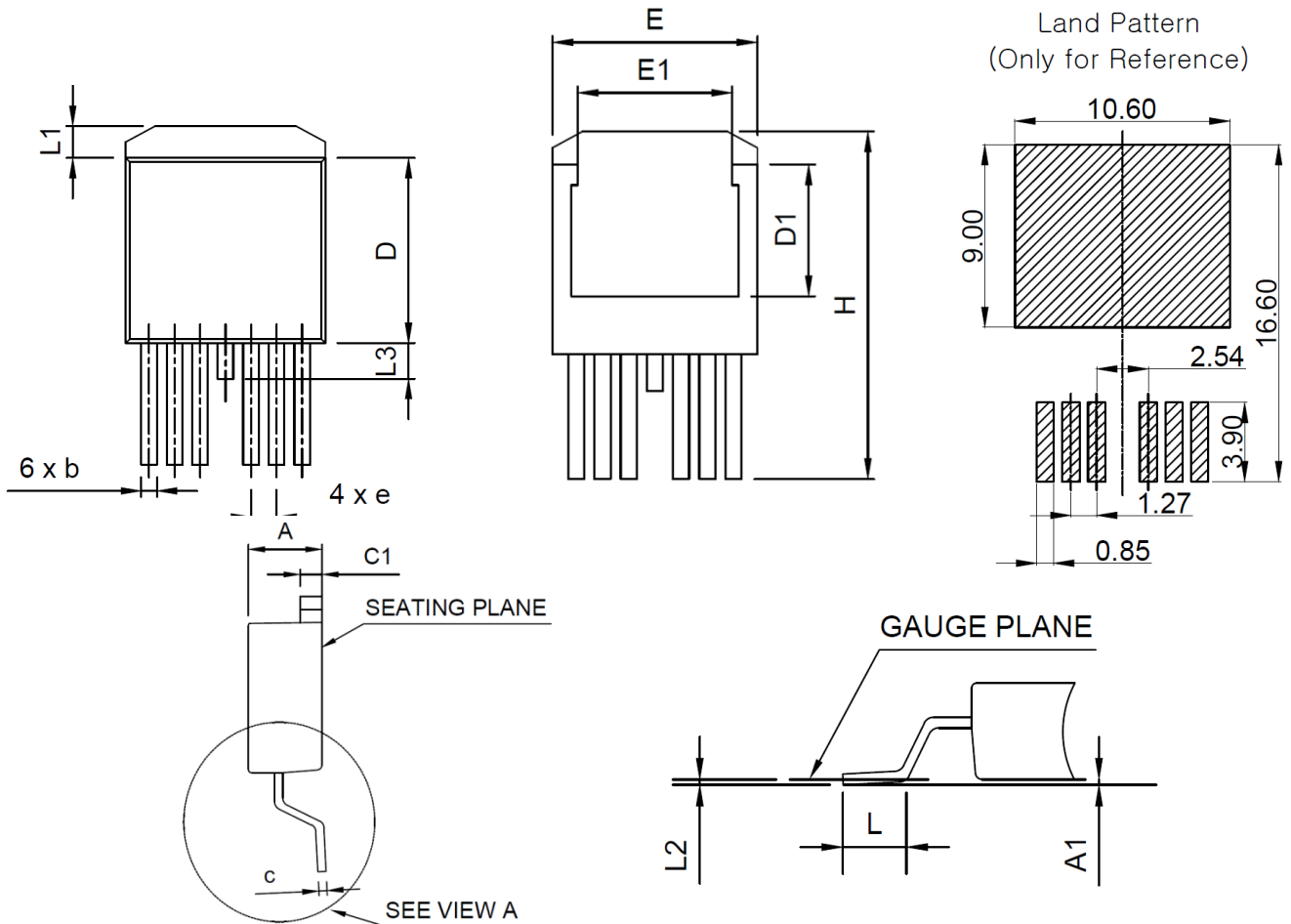

**Fig.11 Transient Thermal Impedance Curve**

## Package Dimension

### TO-263-7P

Dimensions are in millimeters unless otherwise specified



Symbol	Dimension (mm)		
	Min	Nom	Max
A	4.30	-	4.70
A1	-	-	0.254
b	0.65	-	0.90
c	0.40	-	0.60
c1	1.25	-	1.40
D	9.00	-	9.40
D1	5.90	-	6.90
E	9.68	-	10.20
E1	7.70	-	8.50
e	1.27 BSC		
H	14.61	-	15.88
L	1.78	-	2.80
L1	-	-	1.6
L1	0.254 BSC		
L2	-	-	1.78

Note : Package body size, length and width do not include mold flash, protrusions and gate burrs.

**DISCLAIMER:**

The Products are not designed for use in hostile environments, including, without limitation, aircraft, nuclear power generation, medical appliances, and devices or systems in which malfunction of any Product can reasonably be expected to result in a personal injury. Seller's customers using or selling Seller's products for use in such applications do so at their own risk and agree to fully defend and indemnify Seller.

Magnachip reserves the right to change the specifications and circuitry without notice at any time. Magnachip does not consider responsibility for use of any circuitry other than circuitry entirely included in a Magnachip product.  Magnachip is a registered trademark of Magnachip Semiconductor Ltd.