

### General Description

The MDD1902 uses advanced Magnachip's MOSFET Technology, which provides high performance in on-state resistance, fast switching performance and excellent quality. MDD1902 is suitable device for DC/DC Converters and general purpose applications.

### Features

- $V_{DS} = 100V$
- $I_D = 40A$  @  $V_{GS} = 10V$
- $R_{DS(ON)} < 28m\Omega$  @  $V_{GS} = 10V$   
 $< 31m\Omega$  @  $V_{GS} = 6.0V$

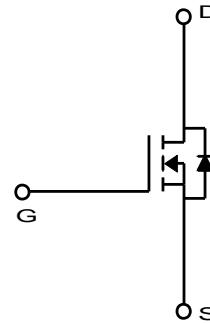
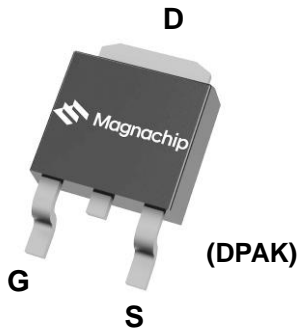

### Absolute Maximum Ratings (Tc = 25°C)

Characteristics		Symbol	Rating	Unit
Drain-Source Voltage		$V_{DSS}$	100	V
Gate-Source Voltage		$V_{GSS}$	$\pm 20$	V
Continuous Drain Current <sup>(1)</sup>	$T_C=25^\circ C$	$I_D$	40	A
	$T_C=100^\circ C$		25	A
Pulsed Drain Current		$I_{DM}$	80	A
Power Dissipation	$T_C=25^\circ C$	$P_D$	83	W
	$T_C=100^\circ C$		33	
Single Pulse Avalanche Energy <sup>(2)</sup>		$E_{AS}$	200	mJ
Junction and Storage Temperature Range		$T_J, T_{stg}$	-55~150	°C

### Thermal Characteristics

Characteristics	Symbol	Rating	Unit
Thermal Resistance, Junction-to-Ambient	$R_{\theta JA}$	50	°C/W
Thermal Resistance, Junction-to-Case <sup>(1)</sup>	$R_{\theta JC}$	1.5	

## Ordering Information

Part Number	Temp. Range	Package	Packing	Rohs Status
MDD1902RH	-55~150°C	DPAK	Tape & Reel	Halogen Free

## Electrical Characteristics (Tc =25°C)

Characteristics	Symbol	Test Condition	Min	Typ	Max	Unit
<b>Static Characteristics</b>						
Drain-Source Breakdown Voltage	$BV_{DSS}$	$I_D = 250\mu A, V_{GS} = 0V$	100	-	-	V
Gate Threshold Voltage	$V_{GS(th)}$	$V_{DS} = V_{GS}, I_D = 250\mu A$	2.0	3.0	4.0	
Drain Cut-Off Current	$I_{DSS}$	$V_{DS} = 80V, V_{GS} = 0V$	-	-	1	$\mu A$
Gate Leakage Current	$I_{GSS}$	$V_{GS} = \pm 20V, V_{DS} = 0V$	-	-	$\pm 0.1$	
Drain-Source ON Resistance	$R_{DS(on)}$	$V_{GS} = 10V, I_D = 20A$	-	21	28	m $\Omega$
		$T_J = 125^\circ C$	-	32	40	
		$V_{GS} = 6.0V, I_D = 20A$	-	23.5	31	
Forward Transconductance	$g_{fs}$	$V_{DS} = 5V, I_D = 20A$	-	55	-	S
<b>Dynamic Characteristics</b>						
Total Gate Charge	$Q_g$	$V_{DS} = 50V, I_D = 20A, V_{GS} = 10V$	-	39.8	48	nC
Gate-Source Charge	$Q_{gs}$		-	11	-	
Gate-Drain Charge	$Q_{gd}$		-	11.2	-	
Input Capacitance	$C_{iss}$	$V_{DS} = 25V, V_{GS} = 0V, f = 1.0MHz$	-	2087	2505	pF
Reverse Transfer Capacitance	$C_{riss}$		-	82	-	
Output Capacitance	$C_{oss}$		-	230	-	
Gate Resistance	$R_g$	$V_{GS}=0V, V_{DS}=0V, F=1MHz$	-	2.1	2.5	$\Omega$
Turn-On Delay Time	$t_{d(on)}$	$V_{DS}=50V, V_{GS}=10V, R_L=3.2\Omega, R_{GEN}=3.2\Omega$	-	10.5		ns
Rise Time	$t_r$		-	27.5		
Turn-Off Delay Time	$t_{d(off)}$		-	38.5		
Fall Time	$t_f$		-	14		
<b>Drain-Source Body Diode Characteristics</b>						
Source-Drain Diode Forward Voltage	$V_{SD}$	$I_S = 1A, V_{GS} = 0V$	-	0.7	1.2	V
Body Diode Reverse Recovery Time	$t_{rr}$	$I_F = 20A, di/dt = 100A/\mu s$	-	63	76	ns
Body Diode Reverse Recovery Charge	$Q_{rr}$		-	145	-	nC

Note :

- Surface mounted RF4 board with 2oz. Copper.
- Starting  $T_J=25^\circ C, L=1mH, I_{AS}=20A, V_{DD}=50V, V_{GS}=10V$

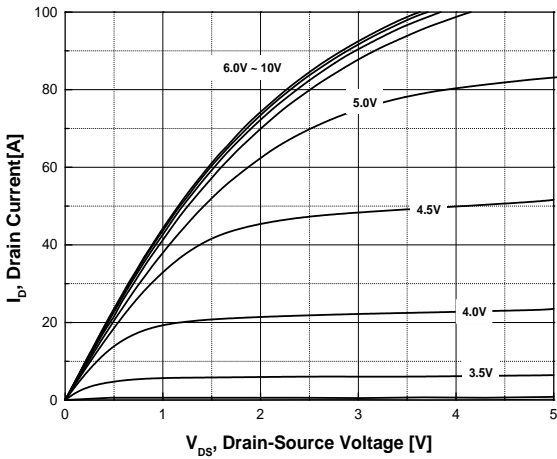

**Fig.1 On-Region Characteristics**

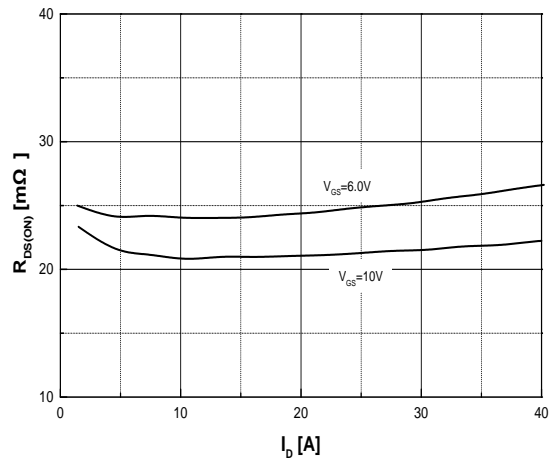

**Fig.2 On-Resistance Variation with Drain Current and Gate Voltage**

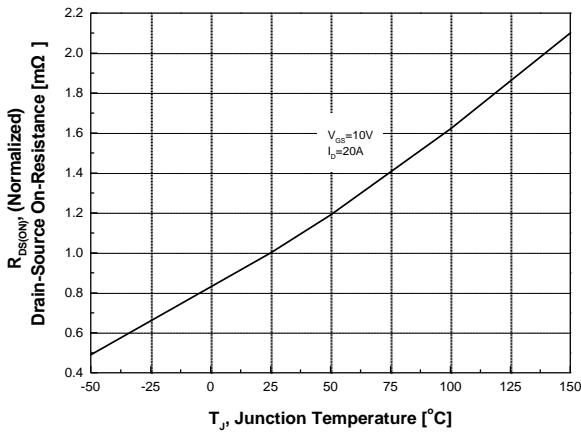

**Fig.3 On-Resistance Variation with Temperature**

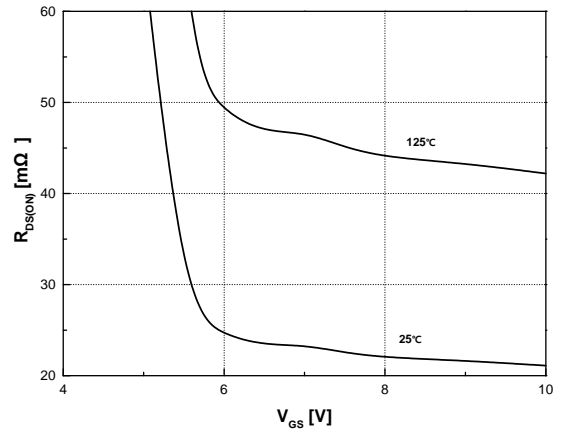

**Fig.4 On-Resistance Variation with Gate to Source Voltage**

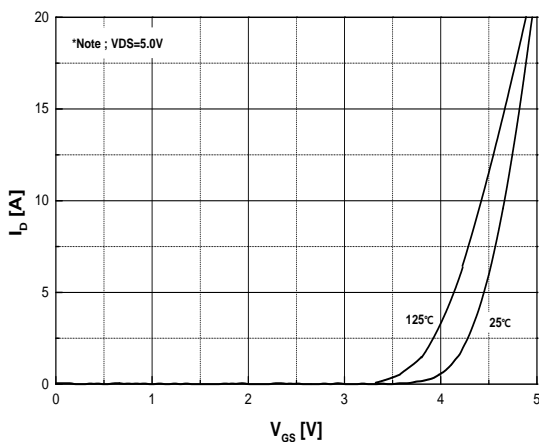

**Fig.5 Transfer Characteristics**

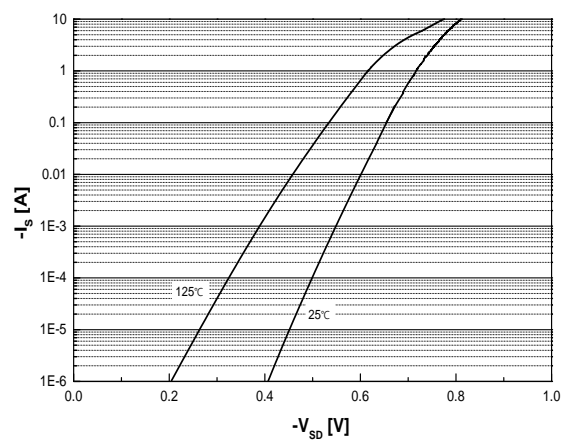

**Fig.6 Body Diode Forward Voltage Variation with Source Current and Temperature**

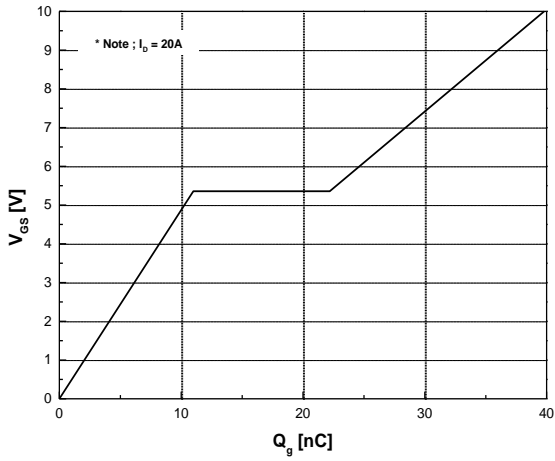

**Fig.7 Gate Charge Characteristics**

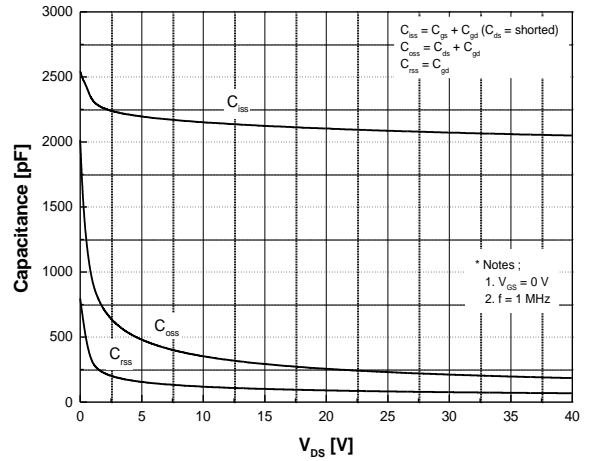

**Fig.8 Capacitance Characteristics**

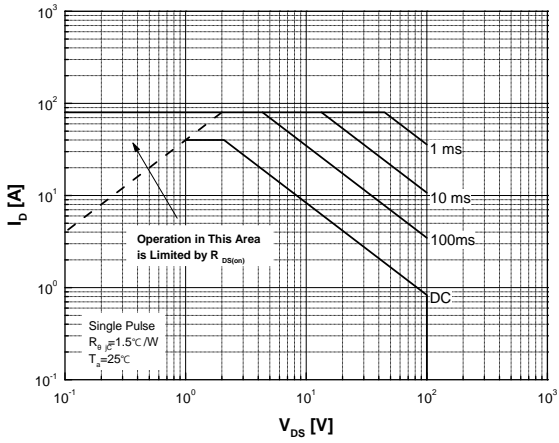

**Fig.9 Maximum Safe Operating Area**

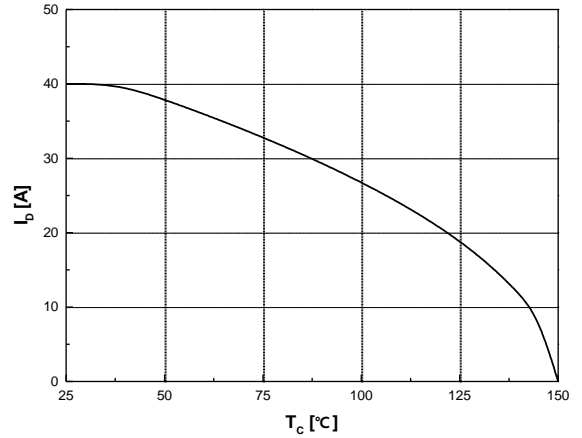

**Fig.10 Maximum Drain Current vs. Case Temperature**

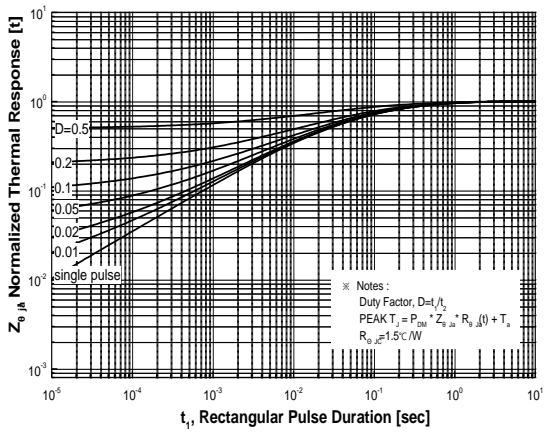
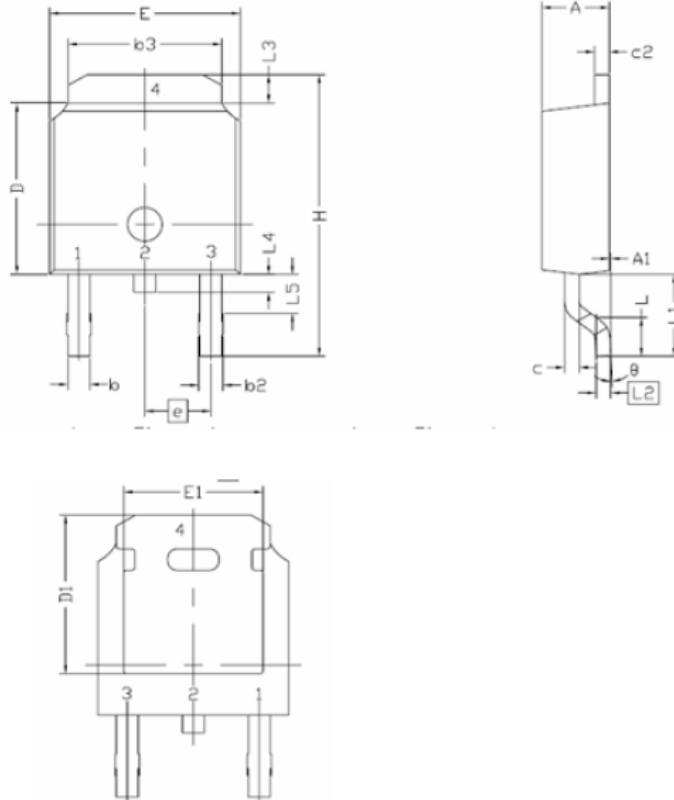

**Fig.11 Transient Thermal Response Curve**

## Package Dimension

### TO-252 (DPAK)

Dimensions are in millimeters, unless otherwise specified



Symbol	Min.	Nom.	Max.
E	6,35	-	6,73
L	1,40	1,52	1,78
L1	2,74 REF		
L2	0,508 BCS		
L3	0,89	-	1,27
L4	-	-	1,02
L5	1,14	-	1,52
D	5,97	6,10	6,22
H	9,40	-	10,41
b	0,64	-	0,89
b2	0,76	-	1,14
b3	4,95	-	5,46
e	2,286 BSC		
A	2,18	-	2,39
A1	-	-	0,13
c	0,46	-	0,61
c2	0,46	-	0,89
D1	5,21	-	-
E1	4,32	-	-
⌀	0,00	-	10,00

Note : Package body size, length and width do not include mold flash, protrusions and gate burrs.

**DISCLAIMER:**

The Products are not designed for use in hostile environments, including, without limitation, aircraft, nuclear power generation, medical appliances, and devices or systems in which malfunction of any Product can reasonably be expected to result in a personal injury. Seller's customers using or selling Seller's products for use in such applications do so at their own risk and agree to fully defend and indemnify Seller.

Magnachip reserves the right to change the specifications and circuitry without notice at any time. Magnachip does not consider responsibility for use of any circuitry other than circuitry entirely included in a Magnachip product.  Magnachip is a registered trademark of Magnachip Semiconductor Ltd.