



MDU04N027RH

Single N-channel Trench MOSFET 40V 2.7mΩ 70A

General description

The MDU04N027RH uses advanced Magnachip's MOSFET Technology, which provides high performance in on-state resistance, fast switching performance, and excellent quality.

This device can be utilized in application such as BLDC motor inverter and Synchronous Rectification.

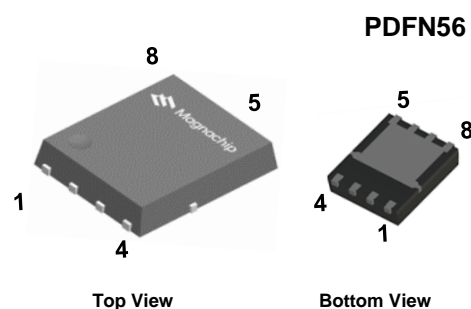

Features and benefits

- Magnachip's MOSFET Technology
- Very low on-resistance $R_{DS(on)}$
- 100% Avalanche / Rg Tested

Applications

- BLDC Motor Inverter
- Synchronous Rectification
- Power Tool

Key performance parameters

V_{DS}	40	V
$R_{DS(on), max}$	0.0027	Ω
I_D	70	A
Q_G	78	nC
Junction temperature, $_{max}$	150	$^{\circ}C$

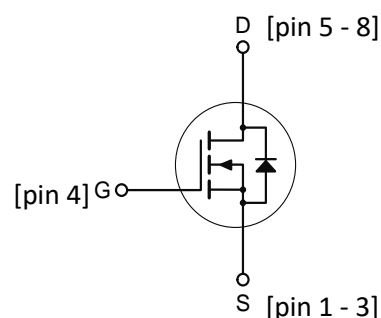

Ordering information

Type / Ordering Code	Package	Marking	Packing	RoHS Status
MDU04N027RH	PDFN56	04N027	Tape & Reel	Halogen Free

<http://www.magnachip.com/powersolutions>



Maximum ratings, at $T_A = 25^\circ\text{C}$, unless otherwise specified

Parameter		Symbol	Rating	Unit
Drain-source Voltage		V_{DS}	40	V
Gate-source Voltage		V_{GS}	± 20	V
1) Drain current	$T_C=25^\circ\text{C}$ Silicon Limited	I_D	127	A
	$T_C=25^\circ\text{C}$ Package Limited		70	A
	$T_C=100^\circ\text{C}$ Silicon Limited		80	A
The Pulsed drain current	$T_C=25^\circ\text{C}$	I_{DM}	280	V
Total power dissipation	$T_C=25^\circ\text{C}$	P_{tot}	74	W
	$T_C=100^\circ\text{C}$		29	W
3) Avalanche energy, single pulse		E_{AS}	162	mJ
Operating and storage temperature		T_j, T_{stg}	- 55 ~ 150	$^\circ\text{C}$

Magnachip's MOSFET Technology

Thermal characteristics

Parameter	Symbol	Rating	Unit
1) Thermal resistance, junction - case	$R_{\theta JC}$	1.7	K/W
Thermal resistance, junction - ambient	$R_{\theta JA}$	50	K/W

Notes

- Surface mounted FR-4 board by JEDEC (jesd51-7)
- Pulse width limited by T_{jmax}
- EAS is tested at starting $T_j = 25^\circ\text{C}$, $L = 1.0\text{mH}$, $I_{AS} = 18\text{A}$, $V_{DD} = 20\text{V}$, $V_{GS} = 10\text{V}$

Electrical Characteristics ($T_J = 25^\circ\text{C}$)

Static characteristics

Parameter	Symbol	Min.	Typ.	Max.	Unit	Conditions / Note
Drain-source breakdown voltage	$V_{(BR)DSS}$	40	-	-	V	$V_{GS}=0\text{ V}$, $I_D=250\ \mu\text{A}$
Gate threshold voltage	$V_{GS(th)}$	1.0	-	3.0	V	$V_{DS}=V_{GS}$, $I_D=250\ \mu\text{A}$
Zero gate voltage drain current	I_{DSS}	-	-	1	μA	$V_{DS}=32\text{ V}$, $V_{GS}=0\text{ V}$
T_h Gate-source leakage current	I_{GSS}	-	-	± 100	nA	$V_{GS}=\pm 20\text{ V}$, $V_{DS}=0\text{ V}$
Drain-source on-state resistance	$R_{DS(on)}$	-	2.2	2.7	m Ω	$V_{GS}=10\text{ V}$, $I_D=27\text{ A}$
Gate resistance	R_G	-	1.2	-	Ω	$f=1\text{ MHz}$
Transconductance	g_{fs}	-	60	-	S	$V_{DS}=10\text{ V}$, $I_D=27\text{ A}$

Dynamic characteristics

Parameter	Symbol	Min.	Typ.	Max.	Unit	Conditions / Note
Input capacitance	C_{iss}	-	4360	-	pF	$V_{GS}=0\text{ V}$, $V_{DS}=20\text{ V}$, $f=1\text{ MHz}$
Output capacitance	C_{oss}	-	1140	-	pF	$V_{GS}=0\text{ V}$, $V_{DS}=20\text{ V}$, $f=1\text{ MHz}$
Reverse transfer capacitance	C_{rss}	-	110	-	pF	$V_{GS}=0\text{ V}$, $V_{DS}=20\text{ V}$, $f=1\text{ MHz}$
Magnachip's MOSFET Technology	$t_{d(on)}$	-	16	-	ns	$V_{DD}=20\text{ V}$, $V_{GS}=10\text{ V}$, $I_D=27\text{ A}$, $R_{G,ext}=3\Omega$
Rise time	t_r	-	14	-	ns	$V_{DD}=20\text{ V}$, $V_{GS}=10\text{ V}$, $I_D=27\text{ A}$, $R_{G,ext}=3\Omega$
Turn-off delay time	$t_{d(off)}$	-	67	-	ns	$V_{DD}=20\text{ V}$, $V_{GS}=10\text{ V}$, $I_D=27\text{ A}$, $R_{G,ext}=3\Omega$
Fall time	t_f	-	22	-	ns	$V_{DD}=20\text{ V}$, $V_{GS}=10\text{ V}$, $I_D=27\text{ A}$, $R_{G,ext}=3\Omega$

Gate charge characteristics

Parameter	Symbol	Min.	Typ.	Max.	Unit	Conditions / Note
Gate to source charge	Q_{gs}	-	11	-	nC	$V_{DD}=20\text{ V}$, $I_D=27\text{ A}$, $V_{GS}=0\text{ to }10\text{ V}$
Gate charge at threshold	$Q_{gs(th)}$	-	8	-	nC	$V_{DD}=20\text{ V}$, $I_D=27\text{ A}$, $V_{GS}=0\text{ to }10\text{ V}$
Gate to drain charge	Q_{gd}	-	15	-	nC	$V_{DD}=20\text{ V}$, $I_D=27\text{ A}$, $V_{GS}=0\text{ to }10\text{ V}$
Switching charge	Q_{sw}	-	18	-	nC	$V_{DD}=20\text{ V}$, $I_D=27\text{ A}$, $V_{GS}=0\text{ to }10\text{ V}$
Gate charge total	Q_g	-	78	-	nC	$V_{DD}=20\text{ V}$, $I_D=27\text{ A}$, $V_{GS}=0\text{ to }10\text{ V}$
Gate plateau voltage	$V_{plateau}$	-	2.9	-	V	$V_{DD}=20\text{ V}$, $I_D=27\text{ A}$, $V_{GS}=0\text{ to }10\text{ V}$

Source-drain diode

Parameter	Symbol	Min.	Typ.	Max.	Unit	Conditions / Note
Diode continuous forward current	I_S	-	-	70	A	-
Diode pulse current	$I_{S,pulse}$	-	-	280	A	pulsed; $t_p \leq 10\ \mu\text{s}$
Diode forward voltage	V_{SD}	-	1.0	1.2	V	$V_{GS}=0\text{ V}$, $I_S=50\text{ A}$
Reverse recovery time	t_{rr}	-	47.5	-	ns	$I_F=27\text{ A}$, $dI_F/dt=100\text{ A}/\mu\text{s}$
Reverse recovery charge	Q_{rr}	-	52	-	nC	$I_F=27\text{ A}$, $dI_F/dt=100\text{ A}/\mu\text{s}$

Electrical characteristics diagrams

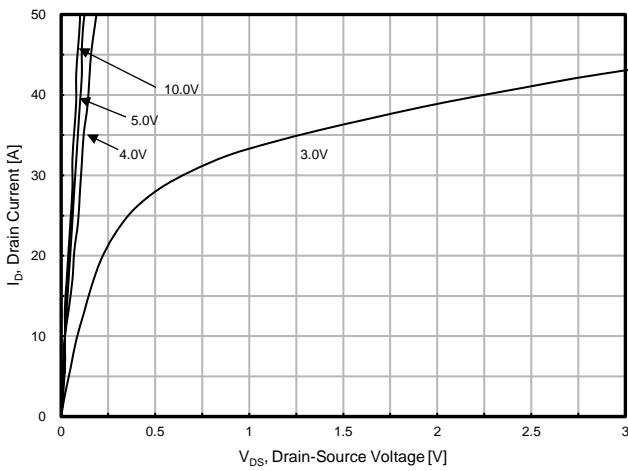

Fig. 1. On-Region Characteristics
Magnachip's MOSFET Technology

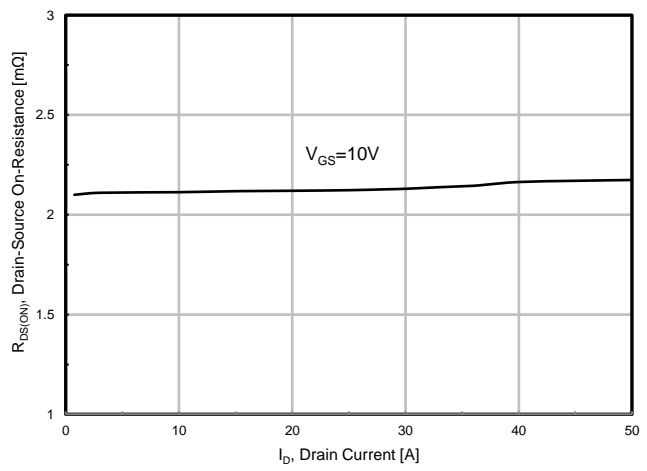

Fig. 2. On-Resistance vs. Drain Current and Gate Voltage

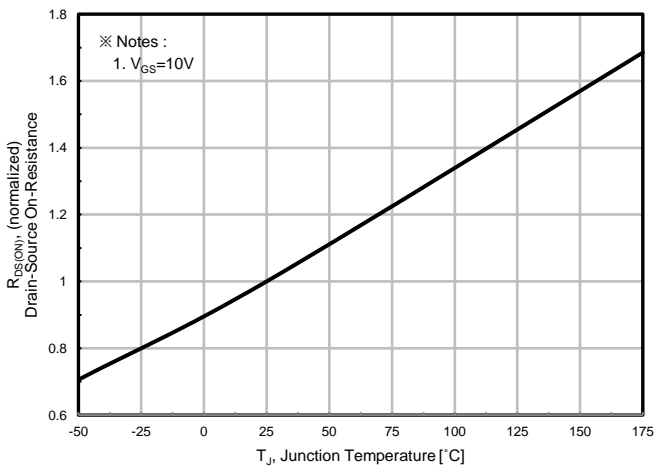

Fig. 3. On-Resistance vs. Junction Temperature

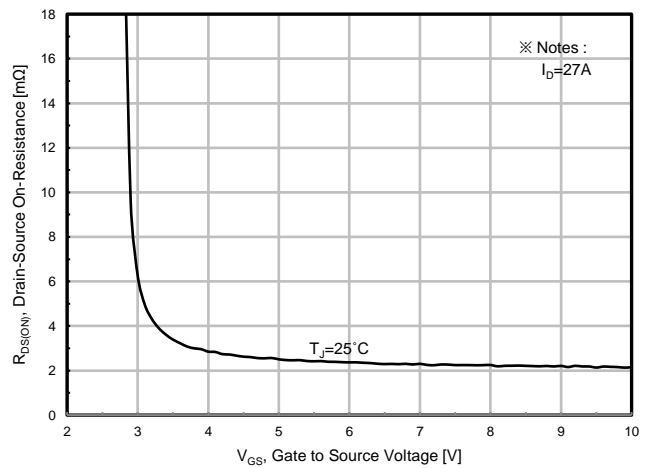

Fig. 4. On-Resistance vs. Gate to Source Voltage

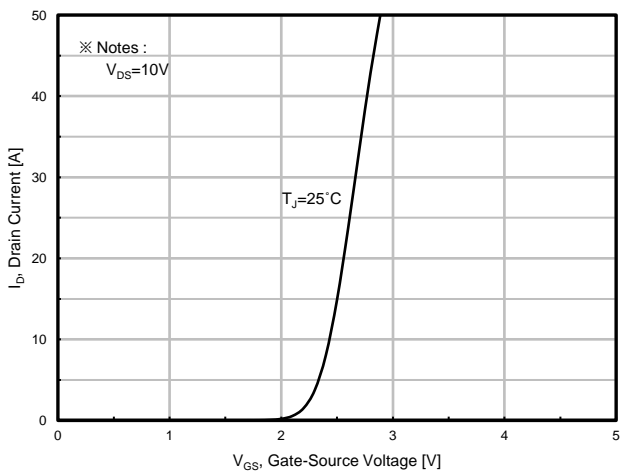

Fig. 5. Transfer Characteristics

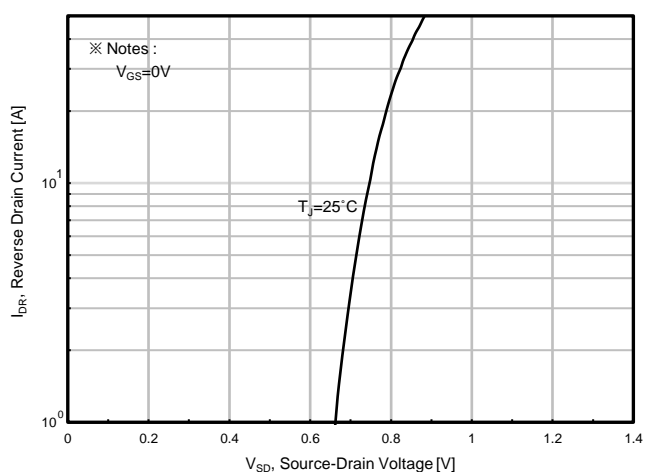

Fig. 6. Source-Drain Diode Forward Voltage

Electrical characteristics diagrams

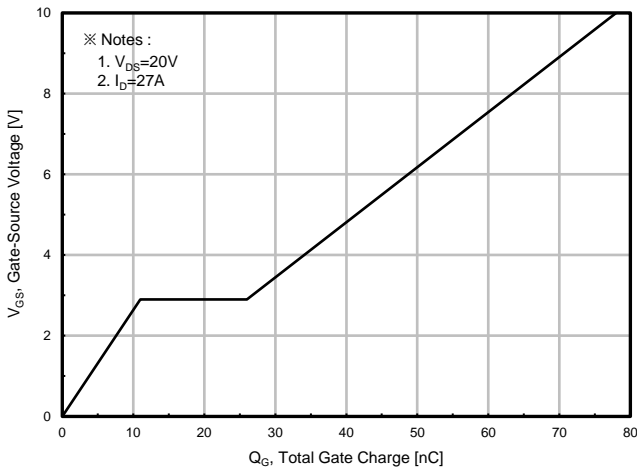

Fig. 7. Gate Charge

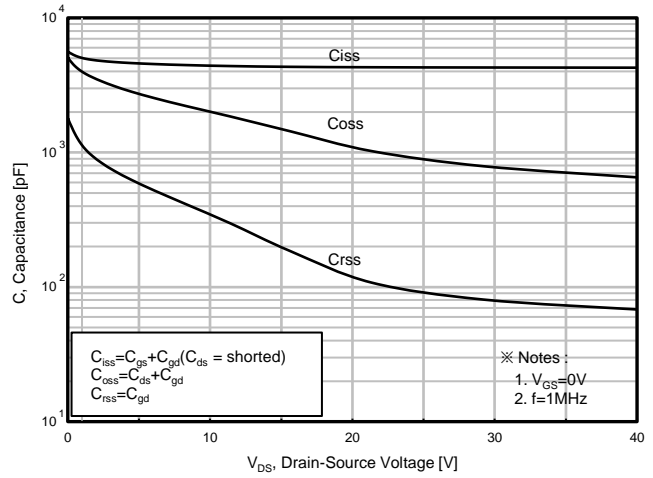

Fig. 8. Capacitance

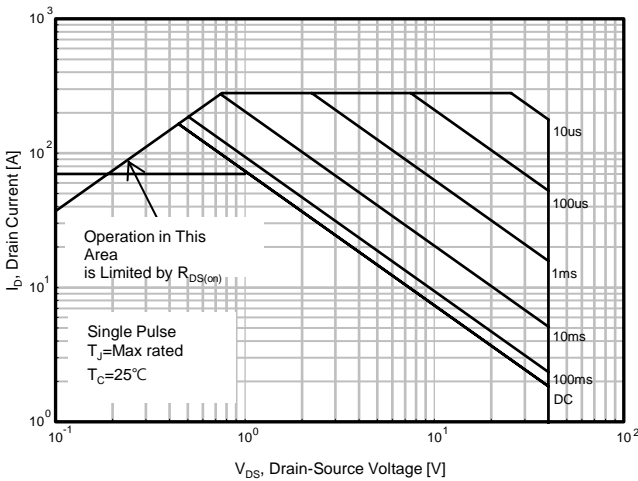

Fig. 9. Safe Operating Area, Junction-to-Ambient

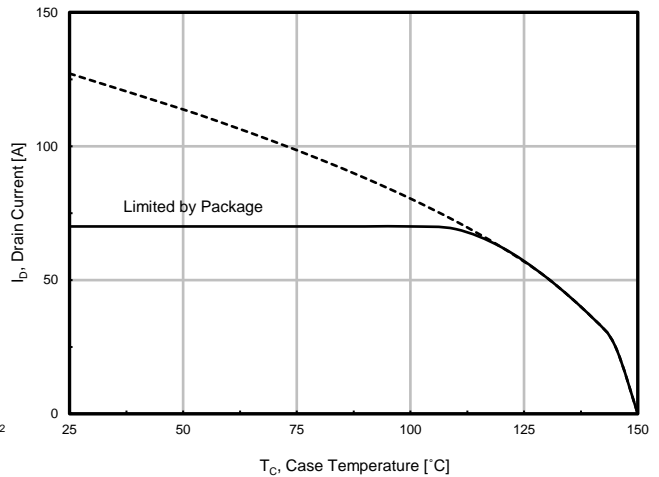

Fig. 10. Maximum Drain vs. Case Temperature

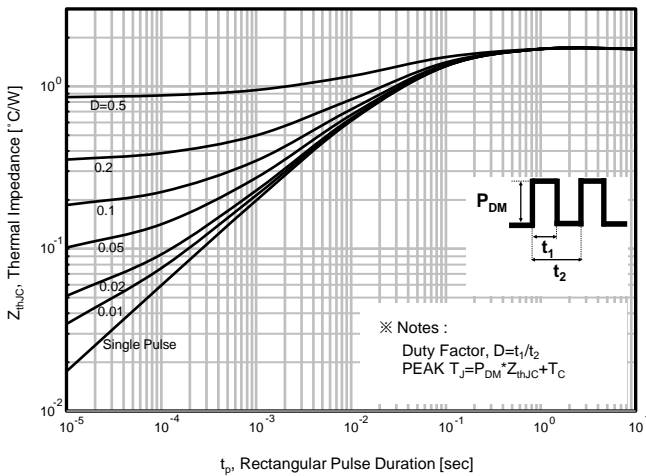
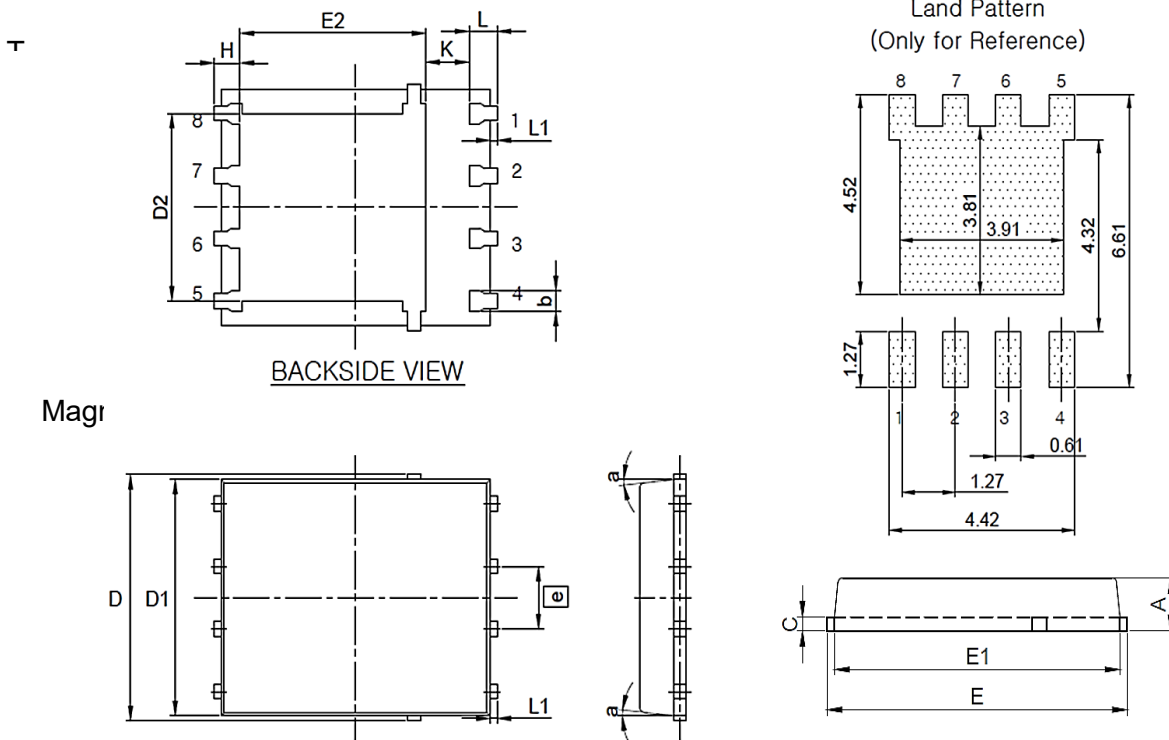

Fig. 11. Thermal Transient Impedance, Junction-to-Case

Package information

PDFN56



Symbol	Dimension (mm)		
	Min.	Norm.	Max.
A	0.90	-	1.10
B	0.33	-	0.51
C	0.20	-	0.34
D	4.50	-	5.30
D1	4.50	-	5.10
D2	3.61	-	4.22
E	5.90	-	6.30
E1	5.50	-	6.10
E2	3.38	-	4.30
e	1.27 BSC		
H	0.41	-	0.71
K	0.20	-	-
L	0.51	-	0.71
L1	0.06	-	0.20
a	0°	-	12°

* Note : Package body size, length and width do not include mold flash, protrusions and gate burs.

DISCLAIMER :

The Products are not designed for use in hostile environments, including, without limitation, aircraft, nuclear power generation, medical appliances, and devices or systems in which malfunction of any Product can reasonably be expected to result in a personal injury. Seller's customers using or selling Seller's products for use in such applications do so at their own risk and agree to fully defend and indemnify Seller.

Magnachip reserves the right to change the specifications and circuitry without notice at any time. Magnachip does not consider responsibility for use of any circuitry other than circuitry entirely included in a Magnachip product.  Magnachip is a registered trademark of Magnachip Semiconductor Ltd.