



MDY10N025RH

Single N-channel Trench MOSFET 100V 2.5mΩ 240A

General description

MDY10N025RH uses advanced MagnaChip's MV MOSFET Technologies, which provides high performance in on-state resistance, fast switching, parallel performance and excellent quality.

MDY10N025RH is the best solution for high power application where thermal behavior.

Driver source pin avoids gate ringing and false triggering which would normally require switching loss to be limited to manage the source stray inductance of normal package.

Features and benefits

- Very low on-resistance $R_{DS(on)}$
- 100% Avalanche / R_g / ΔV_{DS} Tested
- High Reliability Package Solution

Applications

- Motor Inverter
- Battery Management
- Power Inverter

Key performance parameters

V_{DS}	100	V
$R_{DS(on), max}$	0.0025	Ω
I_D	240	A
Q_G	167	nC
Junction temperature, $_{max}$	175	$^{\circ}C$

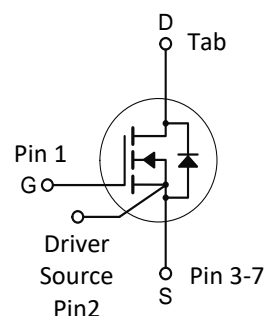
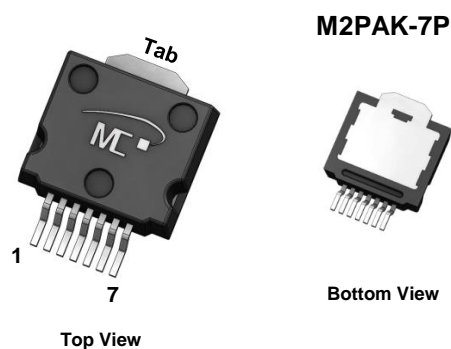

Ordering information

Type / Ordering Code	Package	Marking	Packing	RoHS Status
MDY10N025RH	M2PAK-7P	10N025	Tape & Reel	Halogen Free

<http://www.magnachip.com/powersolutions>



Maximum ratings, at $T_j = 25^\circ\text{C}$, unless otherwise specified

Parameter		Symbol	Rating	Unit
Drain-source Voltage		V_{DS}	100	V
Gate-source Voltage		V_{GS}	± 20	V
Drain current	$T_C=25^\circ\text{C}$ Silicon Limited	I_D	306	A
	$T_C=25^\circ\text{C}$ Package Limited		240	A
	$T_C=100^\circ\text{C}$ Silicon Limited		217	A
¹⁾ Pulsed drain current	$T_C=25^\circ\text{C}$	I_{DM}	960	A
Total power dissipation	$T_C=25^\circ\text{C}$	P_{tot}	469	W
	$T_C=100^\circ\text{C}$		234	W
²⁾ Avalanche energy, single pulse		E_{AS}	613	mJ
Operating and storage temperature		T_j, T_{stg}	- 55 ~ 175	$^\circ\text{C}$

Thermal characteristics

Parameter		Symbol	Rating	Unit
Thermal resistance, junction - case		$R_{\theta JC}$	0.32	$^\circ\text{C/W}$
³⁾ Thermal resistance, junction - ambient		$R_{\theta JA}$	30	$^\circ\text{C/W}$

Notes

- Pulse width limited by T_{jmax}
- E_{AS} is tested at starting $T_j = 25^\circ\text{C}$, $L = 1.0\text{mH}$, $I_{AS} = 35\text{A}$, $V_{DD} = 50\text{V}$, $V_{GS} = 10\text{V}$
- Surface mounted FR-4 board by JEDEC (jesd51-7)

Electrical Characteristics ($T_J = 25^\circ\text{C}$)

Static characteristics

Parameter	Symbol	Min.	Typ.	Max.	Unit	Conditions / Note
Drain-source breakdown voltage	$V_{(BR)DSS}$	100	-	-	V	$V_{GS}=0\text{ V}$, $I_D=250\ \mu\text{A}$
Gate threshold voltage	$V_{GS(th)}$	2.0	2.8	4.0	V	$V_{DS}=V_{GS}$, $I_D=250\ \mu\text{A}$
Zero gate voltage drain current	I_{DSS}	-	-	1	μA	$V_{DS}=100\text{ V}$, $V_{GS}=0\text{ V}$
Gate-source leakage current	I_{GSS}	-	-	± 100	nA	$V_{GS}=\pm 20\text{ V}$, $V_{DS}=0\text{ V}$
Drain-source on-state resistance	$R_{DS(on)}$	-	2.2	2.5	m Ω	$V_{GS}=10\text{ V}$, $I_D=100\text{ A}$
Gate resistance	R_G	-	3.0	-	Ω	$f=1\text{MHz}$
Transconductance	g_{fs}	-	120	-	S	$V_{DS}=10\text{ V}$, $I_D=100\text{ A}$

Dynamic characteristics

Parameter	Symbol	Min.	Typ.	Max.	Unit	Conditions / Note
Input capacitance	C_{iss}	-	12508	-	pF	$V_{GS}=0\text{ V}$, $V_{DS}=50\text{ V}$, $f=1\text{ MHz}$
Output capacitance	C_{oss}	-	1457	-	pF	$V_{GS}=0\text{ V}$, $V_{DS}=50\text{ V}$, $f=1\text{ MHz}$
Reverse transfer capacitance	C_{rss}	-	14	-	pF	$V_{GS}=0\text{ V}$, $V_{DS}=50\text{ V}$, $f=1\text{ MHz}$
Turn-on delay time	$t_{d(on)}$	-	33	-	ns	$V_{DD}=50\text{ V}$, $V_{GS}=10\text{ V}$, $I_D=100\text{ A}$, $R_{G,ext}=3\Omega$
Rise time	t_r	-	21	-	ns	$V_{DD}=50\text{ V}$, $V_{GS}=10\text{ V}$, $I_D=100\text{ A}$, $R_{G,ext}=3\Omega$
Turn-off delay time	$t_{d(off)}$	-	137	-	ns	$V_{DD}=50\text{ V}$, $V_{GS}=10\text{ V}$, $I_D=100\text{ A}$, $R_{G,ext}=3\Omega$
Fall time	t_f	-	43	-	ns	$V_{DD}=50\text{ V}$, $V_{GS}=10\text{ V}$, $I_D=100\text{ A}$, $R_{G,ext}=3\Omega$

Gate charge characteristics

Parameter	Symbol	Min.	Typ.	Max.	Unit	Conditions / Note
Gate to source charge	Q_{gs}	-	45	-	nC	$V_{DD}=50\text{ V}$, $I_D=100\text{ A}$, $V_{GS}=0\text{ to }10\text{ V}$
Gate charge at threshold	$Q_{gs(th)}$	-	39	-	nC	$V_{DD}=50\text{ V}$, $I_D=100\text{ A}$, $V_{GS}=0\text{ to }10\text{ V}$
Gate to drain charge	Q_{gd}	-	37	-	nC	$V_{DD}=50\text{ V}$, $I_D=100\text{ A}$, $V_{GS}=0\text{ to }10\text{ V}$
Switching charge	Q_{sw}	-	43	-	nC	$V_{DD}=50\text{ V}$, $I_D=100\text{ A}$, $V_{GS}=0\text{ to }10\text{ V}$
Gate charge total	Q_g	-	167	-	nC	$V_{DD}=50\text{ V}$, $I_D=100\text{ A}$, $V_{GS}=0\text{ to }10\text{ V}$
Gate plateau voltage	$V_{plateau}$	-	4.3	-	V	$V_{DD}=50\text{ V}$, $I_D=100\text{ A}$, $V_{GS}=0\text{ to }10\text{ V}$

Source-drain diode

Parameter	Symbol	Min.	Typ.	Max.	Unit	Conditions / Note
Diode continuous forward current	I_S	-	-	240	A	-
Diode pulse current	$I_{S,pulse}$	-	-	960	A	pulsed; $t_p \leq 10\ \mu\text{s}$
Diode forward voltage	V_{SD}	-	0.9	1.2	V	$V_{GS}=0\text{ V}$, $I_F=100\text{ A}$
Reverse recovery time	t_{rr}	-	117	-	ns	$I_F=100\text{ A}$, $dI_F/dt=100\text{ A}/\mu\text{s}$
Reverse recovery charge	Q_{rr}	-	408	-	nC	$I_F=100\text{ A}$, $dI_F/dt=100\text{ A}/\mu\text{s}$

Electrical characteristics diagrams

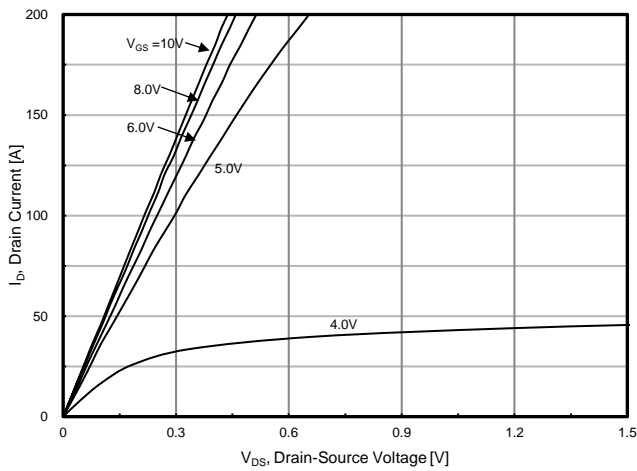

Fig. 1. Output Characteristics

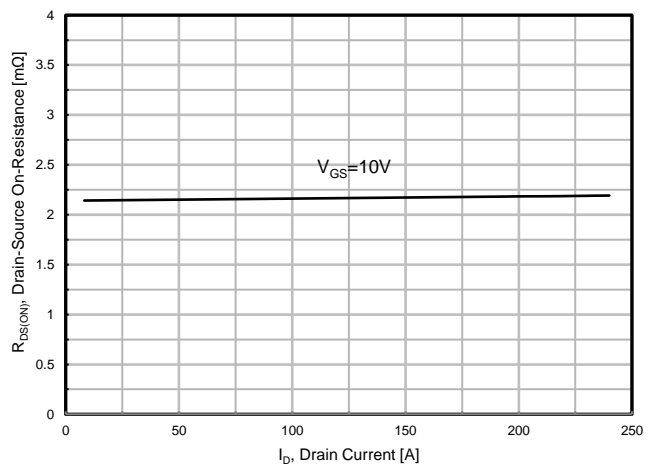

Fig. 2. Static On-Resistance Variation

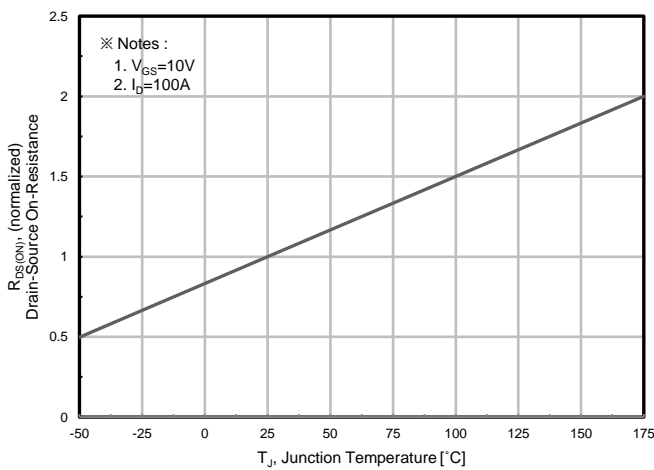

Fig. 3. On-Resistance vs. Junction Temperature

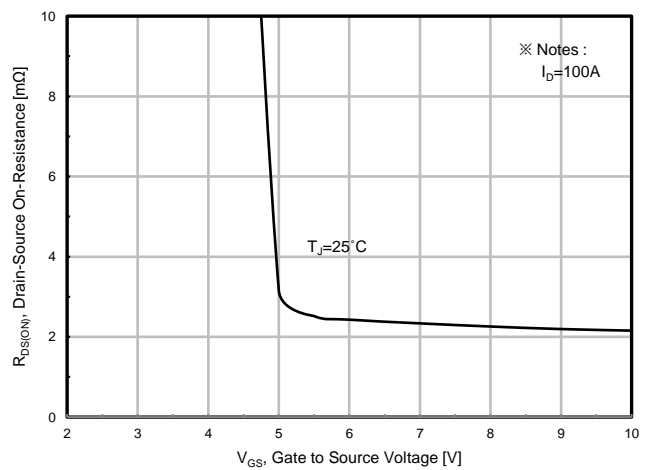

Fig. 4. On-Resistance vs. Gate to Source Voltage

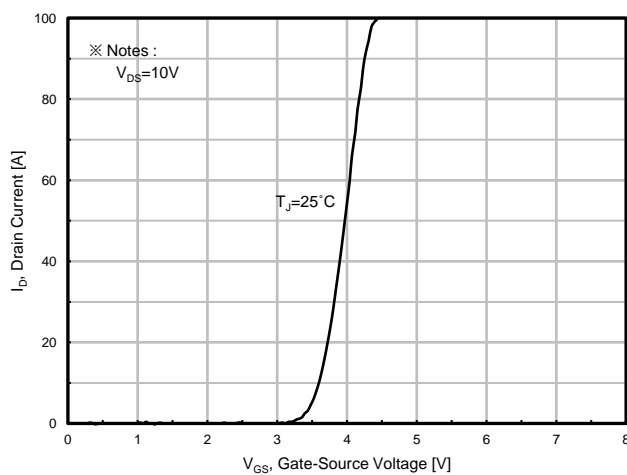

Fig. 5. Transfer Characteristics

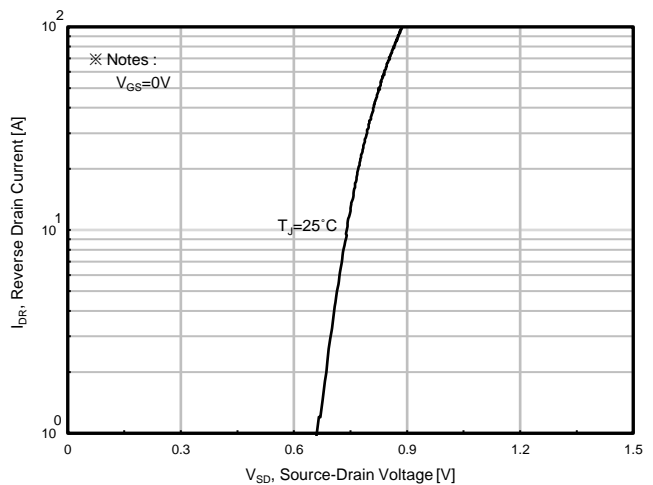

Fig. 6. Body Diode Forward Voltage Variation with Source Current and Temperature

Electrical characteristics diagrams

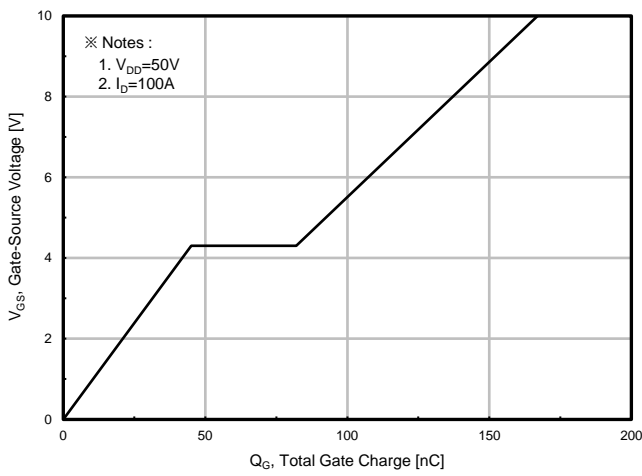

Fig. 7. Gate Charge

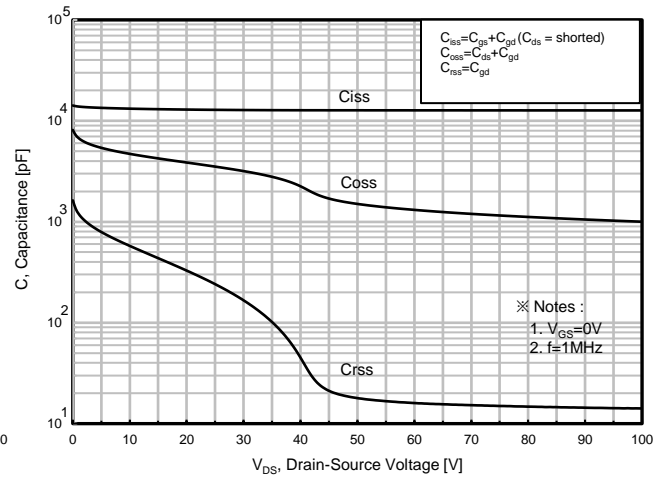

Fig. 8. Capacitances

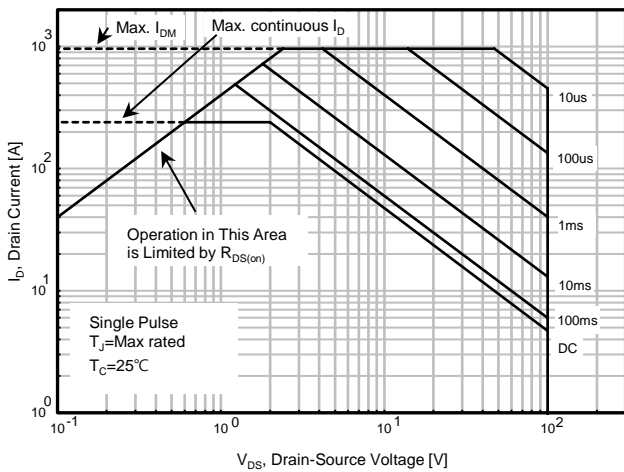

Fig. 9. Safe Operating Area

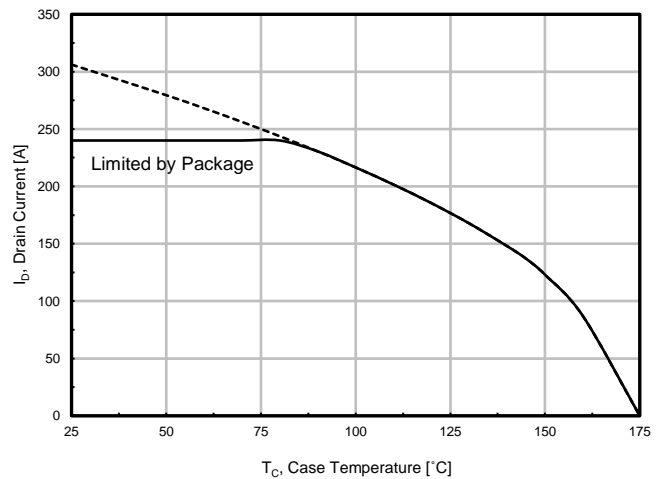

Fig. 10. Maximum Drain Current vs. Case Temperature

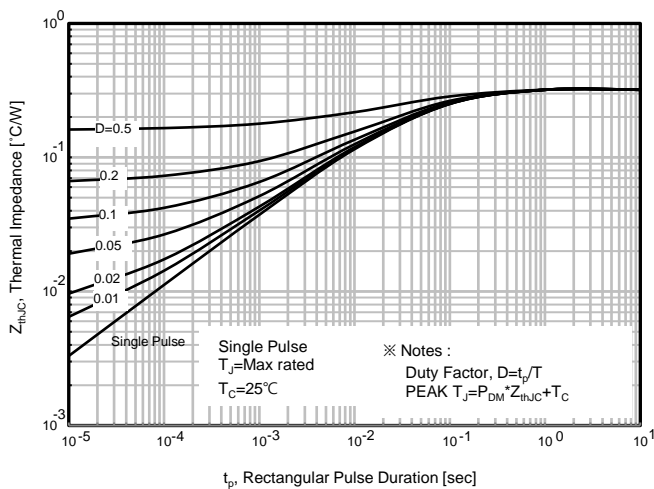
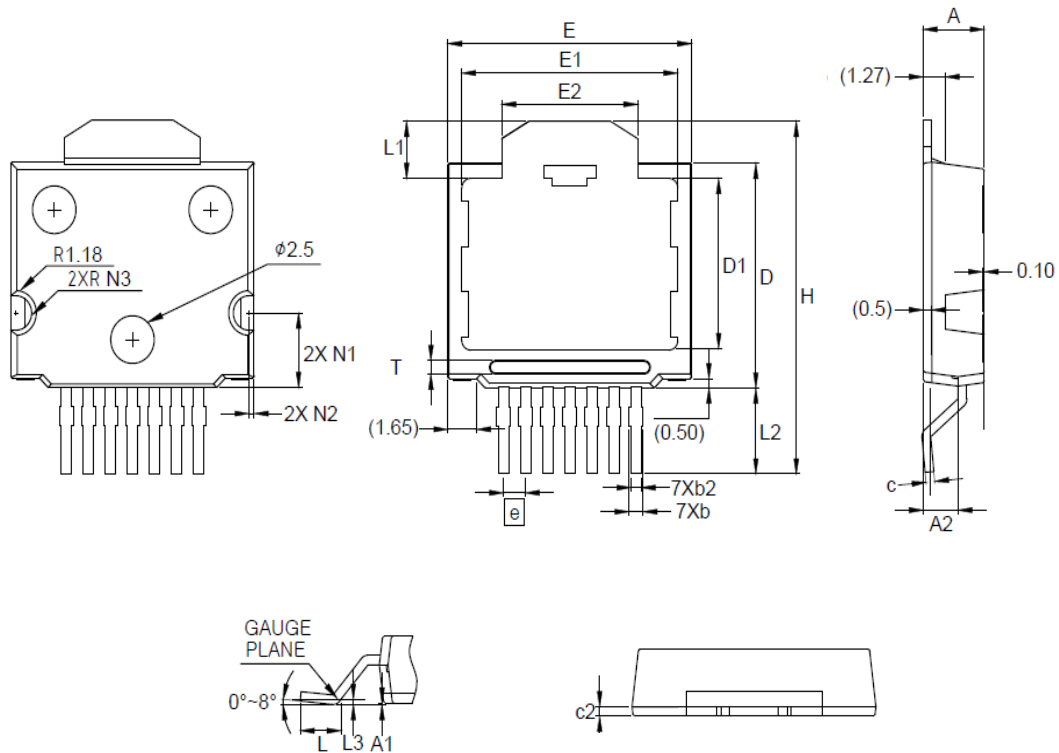

Fig. 11. Transient Thermal Impedance

Package information

M2PAK-7P



Symbol	Dimension (mm)		
	Min	Nom	Max
A	3,40	-	3,60
A1	0,00	-	0,25
A2	1,80	-	2,20
b	0,50	-	0,70
b2	0,50	-	1,00
c	0,40	-	0,60
c2	0,40	-	0,60
D	11,70	-	11,90
D1	8,90	-	9,10
E	13,90	-	14,10
E1	12,30	-	12,50
E2	7,75	-	7,85
T	0,60		0,70
e	BSC 1,27		
H	18,00	-	19,00
L	2,22	-	2,42
L1	2,90	-	3,10
L2	4,35	-	4,65
L3	BSC 0,25		
N1	3,80	-	4,00
N2	0,25	-	0,35
N3	0,80	-	1,00

Notes

PKG dimension does not include mold burr and flash

DISCLAIMER :

The Products are not designed for use in hostile environments, including, without limitation, aircraft, nuclear power generation, medical appliances, and devices or systems in which malfunction of any Product can reasonably be expected to result in a personal injury. Seller's customers using or selling Seller's products for use in such applications do so at their own risk and agree to fully defend and indemnify Seller.

MagnaChip reserves the right to change the specifications and circuitry without notice at any time. MagnaChip does not consider responsibility for use of any circuitry other than circuitry entirely included in a MagnaChip product. MagnaChip[®], MC[®] are registered trademarks of MagnaChip Semiconductor Ltd.