

General Description

The MDU3603 uses advanced MagnaChip's MOSFET Technology to provide low on-state resistance.

This device is suited for Power Management and load switching applications common in Notebook Computers and Portable Battery Packs.

Features

- $V_{DS} = -30V$
- $I_D = -67A$ @ $V_{GS} = -10V$
- $R_{DS(ON)}$
 $< 7.5m\Omega$ @ $V_{GS} = -20V$
 $< 9.1m\Omega$ @ $V_{GS} = -10V$
 $< 13.6m\Omega$ @ $V_{GS} = -5V$

Applications

- Load Switch
- General purpose applications
- Smart Module for Note PC Battery

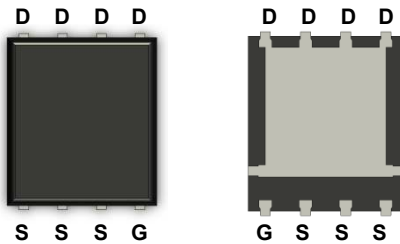

PDFN56

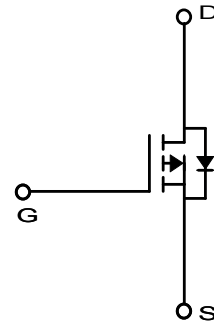

Absolute Maximum Ratings ($T_a = 25^\circ C$ unless otherwise noted)

Characteristics	Symbol	Rating	Unit
Drain-Source Voltage	V_{DSS}	-30	V
Gate-Source Voltage	V_{GSS}	± 25	V
Continuous Drain Current (Silicon limited)	I_D	-67	A
Pulsed Drain Current	I_{DM}	-120	A
Power Dissipation (Note 1)	P_D	2.5	W
Single Pulse Avalanche Energy (Note 2)	E_{AS}	112.5	mJ
Junction and Storage Temperature Range	T_J, T_{stg}	-55~150	$^\circ C$

Thermal Characteristics

Characteristics	Symbol	Rating	Unit
Thermal Resistance, Junction-to-Ambient (Note 1)	$R_{\theta JA}$	50	$^\circ C/W$
Thermal Resistance, Junction-to-Case	$R_{\theta JC}$	2	

Ordering Information

Part Number	Temp. Range	Package	Packing	Quantity	RoHS Status
MDU3603RH	-55~150°C	PowerDFN56	Tape & Reel	3000 units	Halogen Free

Electrical Characteristics (T_a = 25°C unless otherwise noted)

Characteristics	Symbol	Test Condition	Min	Typ	Max	Unit
Static Characteristics						
Drain-Source Breakdown Voltage	BV _{DSS}	I _D = -250μA, V _{GS} = 0V	-30	-	-	V
Gate Threshold Voltage	V _{GS(th)}	V _{DS} = V _{GS} , I _D = -250μA	-1.0	-1.8	-3.0	
Drain Cut-Off Current	I _{DSS}	V _{DS} = -30V, V _{GS} = 0V	-		-1	μA
Gate Leakage Current	I _{GSS}	V _{GS} = ±25V, V _{DS} = 0V	-	-	±0.1	
Drain-Source ON Resistance	R _{DS(ON)}	V _{GS} = -20V, I _D = -12A	-	6.4	7.5	mΩ
		V _{GS} = -10V, I _D = -12A	-	7.5	9.1	
		V _{GS} = -5V, I _D = -10A		10.8	13.6	
Forward Transconductance	g _{FS}	V _{DS} = -5V, I _D = -10A		34	-	S
Dynamic Characteristics						
Total Gate Charge	Q _g	V _{DS} = -15V, I _D = -12A V _{GS} = -10V	-	38.4	-	nC
Gate-Source Charge	Q _{gs}		-	5.9	-	
Gate-Drain Charge	Q _{gd}		-	8.2	-	
Input Capacitance	C _{iss}	V _{DS} = -15V, V _{GS} = 0V, f = 1.0MHz	-	1788	-	pF
Reverse Transfer Capacitance	C _{rss}		-	268	-	
Output Capacitance	C _{oss}		-	445	-	
Turn-On Delay Time	t _{d(on)}	V _{GS} = -10V, V _{DS} = -15V, R _L = 1.25Ω, R _{GEN} = 3Ω	-	15.3	-	ns
Turn-On Rise Time	t _r		-	13.0	-	
Turn-Off Delay Time	t _{d(off)}		-	61.6	-	
Turn-Off Fall Time	t _f		-	53.2	-	
Drain-Source Body Diode Characteristics						
Source-Drain Diode Forward Voltage	V _{SD}	I _S = -1A, V _{GS} = 0V	-	-0.71	-1.0	V
Body Diode Reverse Recovery Time	t _{rr}	I _F = -12A, di/dt = 100A/μs	-	42.3		ns
Body Diode Reverse Recovery Charge	Q _{rr}		-	40.7	-	nC

Note :

1. Surface mounted FR-4 board by JEDEC (jesd51-7)
2. Starting T_J=25°C, L=1mH, I_{AS}= -15A V_{DD}=-20V, V_{GS}=-10V.

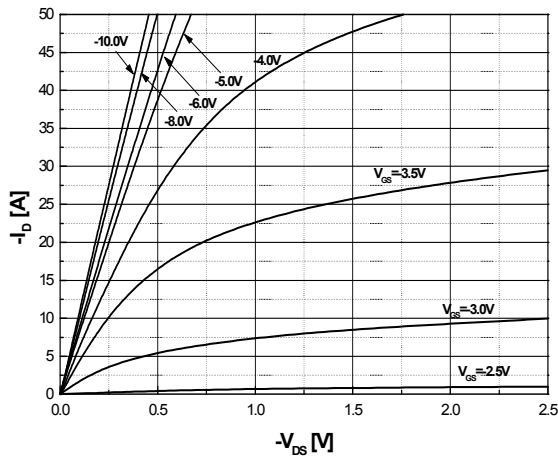

Fig.1 On-Region Characteristics

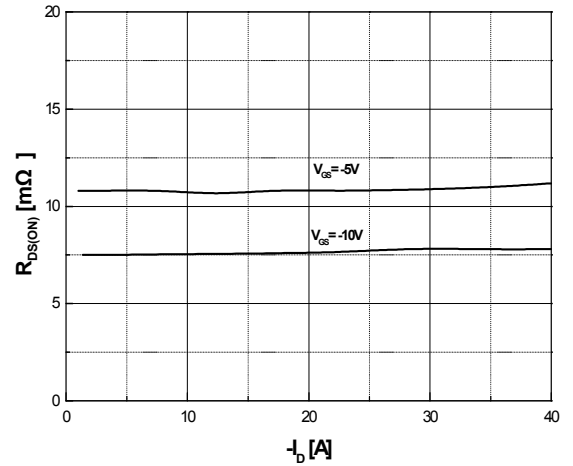

Fig.2 On-Resistance Variation with Drain Current and Gate Voltage

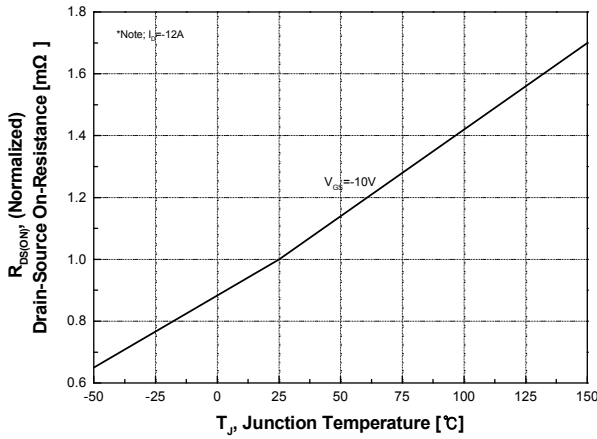

Fig.3 On-Resistance Variation with Temperature

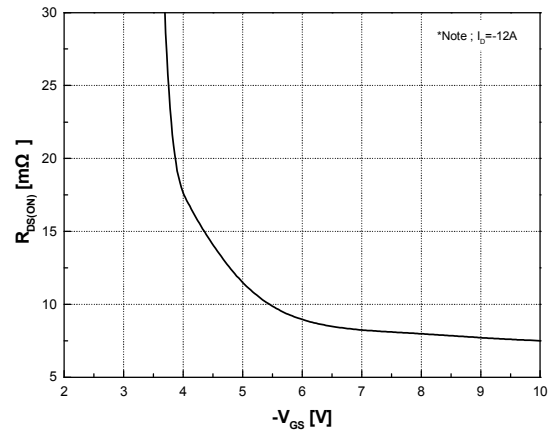

Fig.4 On-Resistance Variation with Gate to Source Voltage

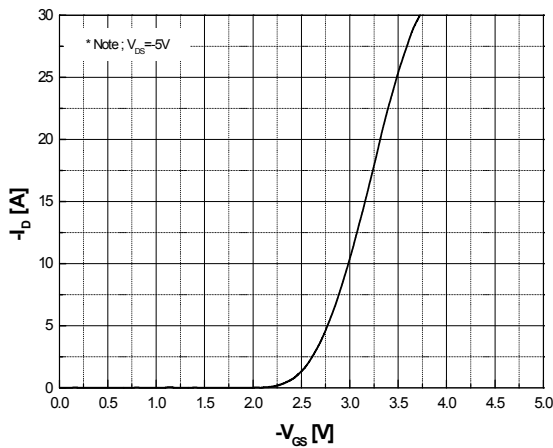

Fig.5 Transfer Characteristics

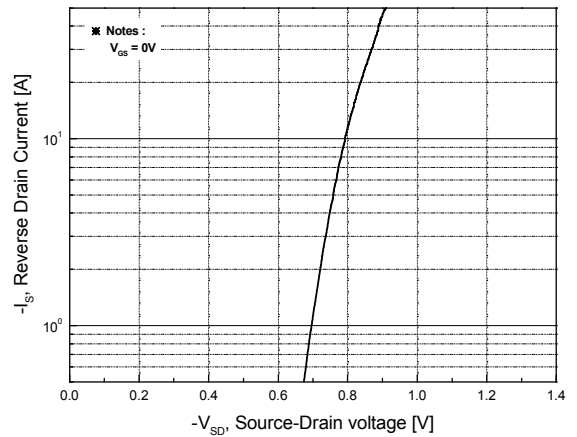

Fig.6 Body Diode Forward Voltage Variation with Source Current and Temperature

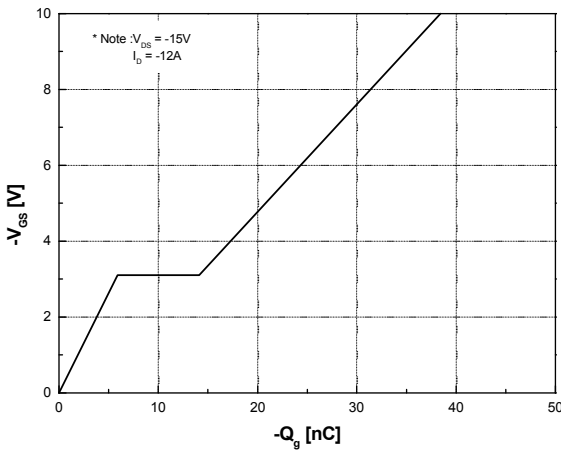

Fig.7 Gate Charge Characteristics

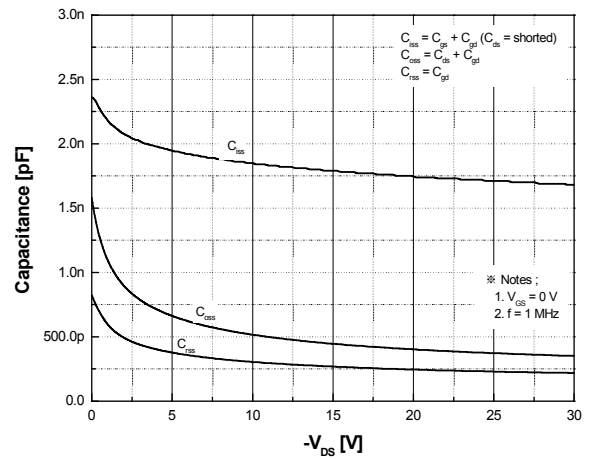

Fig.8 Capacitance Characteristics

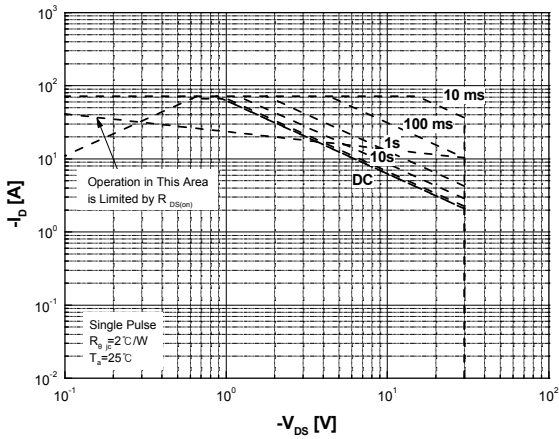

Fig.9 Maximum Safe Operating Area

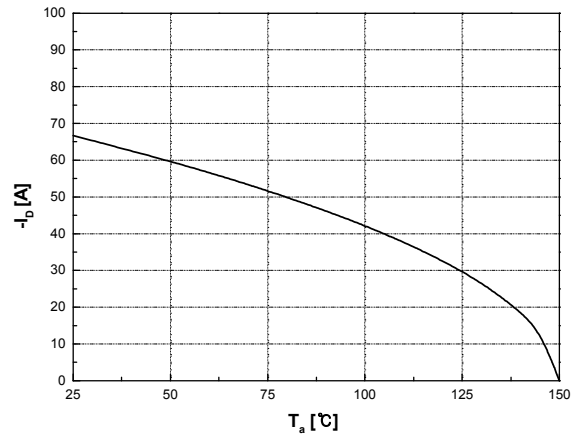

Fig.10 Maximum Drain Current vs. Ambient Temperature

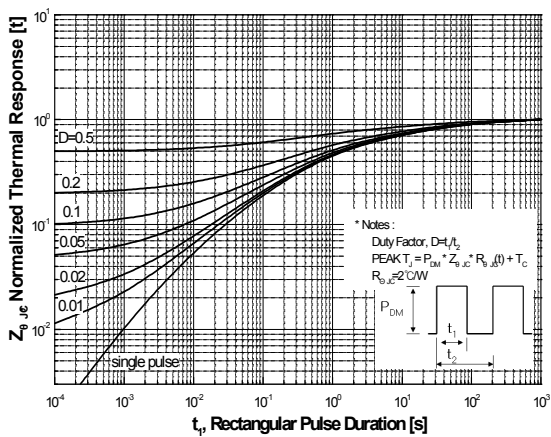
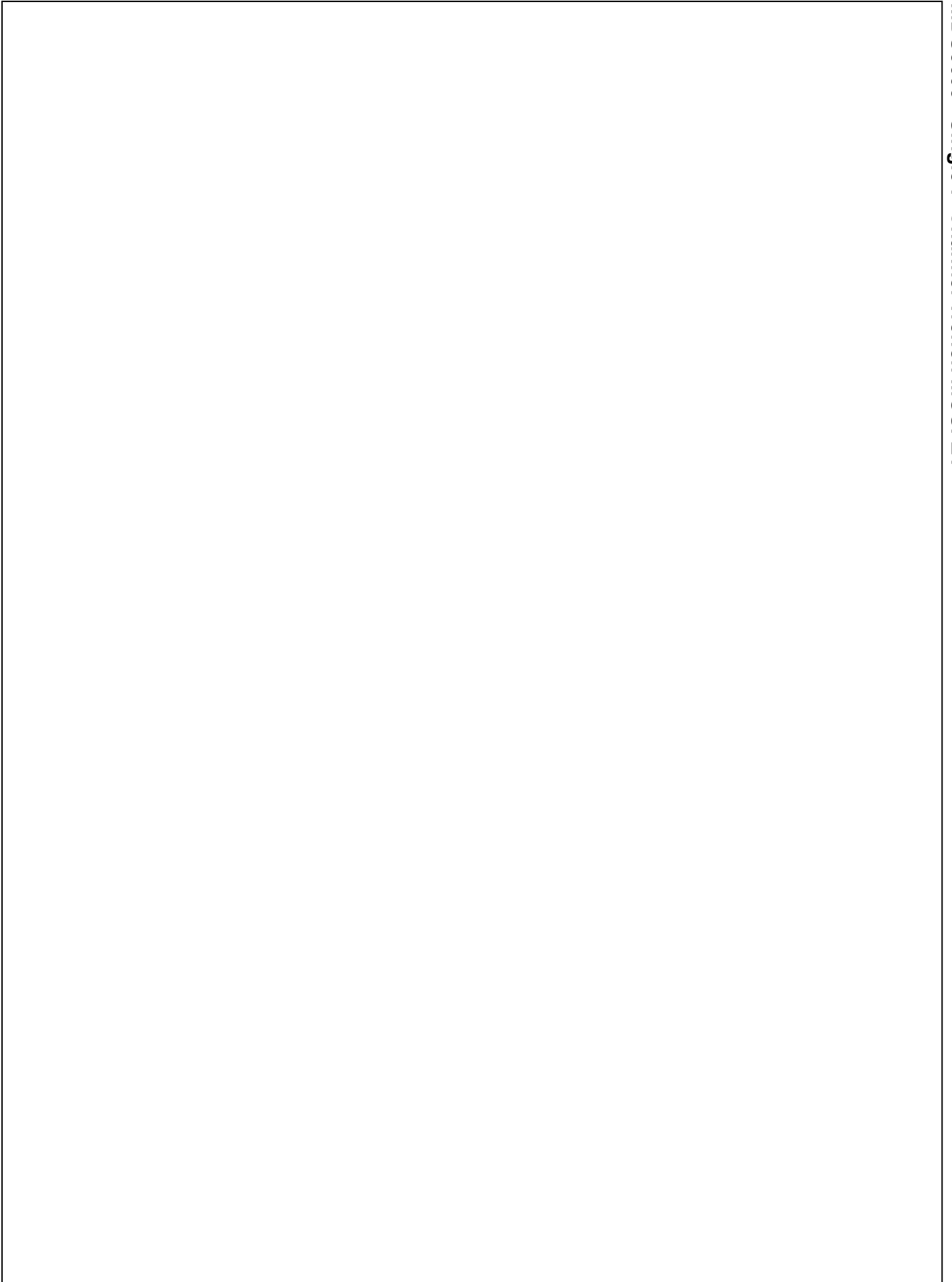

Fig.11 Transient Thermal Response Curve



Package Dimension

PowerDFN56 (5x6mm)

Dimensions are in millimeters, unless otherwise specified

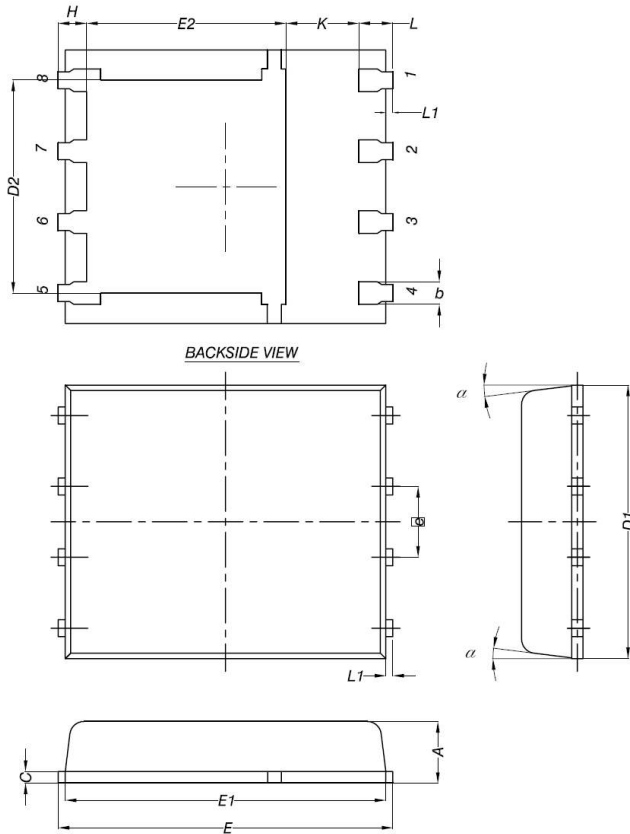

Dimension	MILLIMETERS	
	Min	Max
A	0.90	1.10
b	0.33	0.51
C	0.20	0.34
D1	4.50	5.10
D2	-	4.22
E	5.90	6.30
E1	5.50	6.10
E2	-	4.30
e	1.27BSC	
H	0.41	0.71
K	0.20	-
L	0.51	0.71
α	0°	12°

Land Pattern

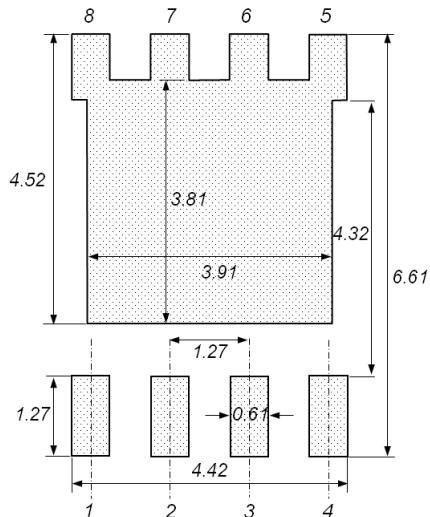

DISCLAIMER:

The Products are not designed for use in hostile environments, including, without limitation, aircraft, nuclear power generation, medical appliances, and devices or systems in which malfunction of any Product can reasonably be expected to result in a personal injury. Seller's customers using or selling Seller's products for use in such applications do so at their own risk and agree to fully defend and indemnify Seller.

MagnaChip reserves the right to change the specifications and circuitry without notice at any time. MagnaChip does not consider responsibility for use of any circuitry other than circuitry entirely included in a MagnaChip product. [MagnaChip](#) is a registered trademark of MagnaChip Semiconductor Ltd.