

### General Description

The MDU1513 uses advanced MagnaChip's MOSFET Technology, which provides high performance in on-state resistance, fast switching performance and excellent quality. MDU1513 is suitable device for DC/DC Converter and general purpose applications.

### Features

- $V_{DS} = 30V$
- $I_D = 88.1A @ V_{GS} = 10V$
- $R_{DS(ON)} < 4.6 m\Omega @ V_{GS} = 10V$   
 $< 7.0 m\Omega @ V_{GS} = 4.5V$
- 100% UIL Tested
- 100% Rg Tested

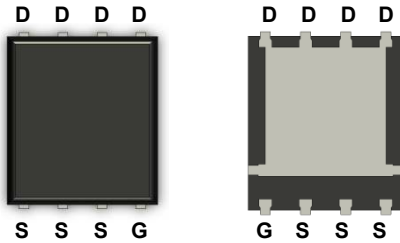

PowerDFN56

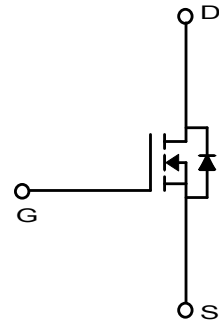

### Absolute Maximum Ratings (Ta = 25°C)

Characteristics		Symbol	Rating	Unit
Drain-Source Voltage		$V_{DSS}$	30	V
Gate-Source Voltage		$V_{GSS}$	±20	V
Continuous Drain Current <sup>(1)</sup>	$T_C=25^\circ C$	$I_D$	88.1	A
	$T_C=70^\circ C$		70.4	
	$T_A=25^\circ C$		26.1 <sup>(3)</sup>	
	$T_A=70^\circ C$		20.8 <sup>(3)</sup>	
Pulsed Drain Current		$I_{DM}$	100	A
Power Dissipation	$T_C=25^\circ C$	$P_D$	62.5	W
	$T_C=70^\circ C$		40.0	
	$T_A=25^\circ C$		5.5 <sup>(3)</sup>	
	$T_A=70^\circ C$		3.5 <sup>(3)</sup>	
Single Pulse Avalanche Energy <sup>(2)</sup>		$E_{AS}$	118	mJ
Junction and Storage Temperature Range		$T_J, T_{stg}$	-55~150	°C

### Thermal Characteristics

Characteristics	Symbol	Rating	Unit
Thermal Resistance, Junction-to-Ambient <sup>(1)</sup>	$R_{\theta JA}$	22.7	°C/W
Thermal Resistance, Junction-to-Case	$R_{\theta JC}$	2.0	

## Ordering Information

Part Number	Temp. Range	Package	Packing	Quantity	RoHS Status
MDU1513URH	-55~150°C	PowerDFN56	Tape & Reel	3000 units	Halogen Free

## Electrical Characteristics (T<sub>J</sub> =25°C)

Characteristics	Symbol	Test Condition	Min	Typ	Max	Unit
<b>Static Characteristics</b>						
Drain-Source Breakdown Voltage	BV <sub>DSS</sub>	I <sub>D</sub> = 250μA, V <sub>GS</sub> = 0V	30	-	-	V
Gate Threshold Voltage	V <sub>GS(th)</sub>	V <sub>DS</sub> = V <sub>GS</sub> , I <sub>D</sub> = 250μA	1.3	1.9	2.7	
Drain Cut-Off Current	I <sub>DSS</sub>	V <sub>DS</sub> = 30V, V <sub>GS</sub> = 0V	-	-	1	μA
Gate Leakage Current	I <sub>GSS</sub>	V <sub>GS</sub> = ±20V, V <sub>DS</sub> = 0V	-	-	±0.1	
Drain-Source ON Resistance	R <sub>DS(ON)</sub>	V <sub>GS</sub> = 10V, I <sub>D</sub> = 20A	-	4.0	4.6	mΩ
		T <sub>J</sub> =125°C	-	5.8	6.7	
Forward Transconductance	g <sub>fs</sub>	V <sub>DS</sub> = 5V, I <sub>D</sub> = 10A	-	35	-	S
<b>Dynamic Characteristics</b>						
Total Gate Charge	Q <sub>g(10V)</sub>	V <sub>DS</sub> = 15.0V, I <sub>D</sub> = 20A, V <sub>GS</sub> = 10V	20.3	27.0	33.8	nC
Total Gate Charge	Q <sub>g(4.5V)</sub>		9.7	12.9	16.1	
Gate-Source Charge	Q <sub>gs</sub>		-	5.4	-	
Gate-Drain Charge	Q <sub>gd</sub>		-	4.3	-	
Input Capacitance	C <sub>iss</sub>	V <sub>DS</sub> = 15.0V, V <sub>GS</sub> = 0V, f = 1.0MHz	1295	1726	2158	pF
Reverse Transfer Capacitance	C <sub>rss</sub>		127	169	211	
Output Capacitance	C <sub>oss</sub>		247	329	411	
Turn-On Delay Time	t <sub>d(on)</sub>	V <sub>GS</sub> = 10V, V <sub>DS</sub> = 15.0V, I <sub>D</sub> = 20A, R <sub>G</sub> = 3.0Ω	-	9.9	-	ns
Rise Time	t <sub>r</sub>		-	12.1	-	
Turn-Off Delay Time	t <sub>d(off)</sub>		-	33.5	-	
Fall Time	t <sub>f</sub>		-	9.5	-	
Gate Resistance	R <sub>g</sub>	f=1 MHz	-	1.5	2.5	Ω
<b>Drain-Source Body Diode Characteristics</b>						
Source-Drain Diode Forward Voltage	V <sub>SD</sub>	I <sub>S</sub> = 20A, V <sub>GS</sub> = 0V	-	0.8	1.1	V
Body Diode Reverse Recovery Time	t <sub>rr</sub>	I <sub>F</sub> = 20A, di/dt = 100A/μs	-	27.3	41.0	ns
Body Diode Reverse Recovery Charge	Q <sub>rr</sub>		-	19.7	29.6	nC

Note :

- Surface mounted FR-4 board by JEDEC (jesd51-7)
- E<sub>AS</sub> is tested at starting T<sub>J</sub> = 25°C, L = 0.1mH, I<sub>AS</sub> = 27A, V<sub>DD</sub> = 27V, V<sub>GS</sub> = 10V.
- T < 10sec

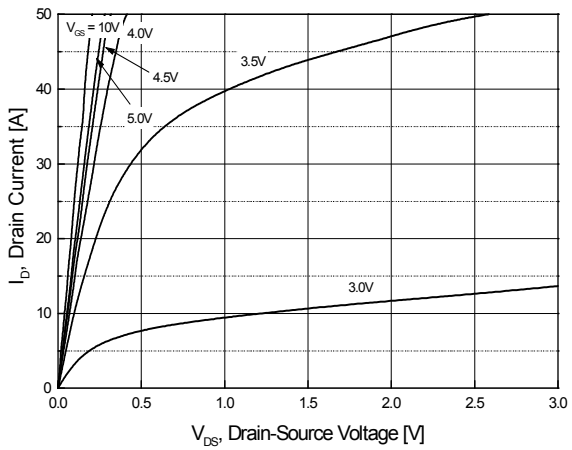

**Fig.1 On-Region Characteristics**

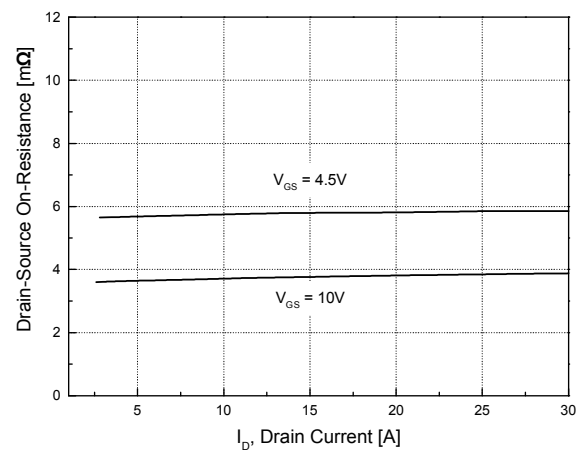

**Fig.2 On-Resistance Variation with Drain Current and Gate Voltage**

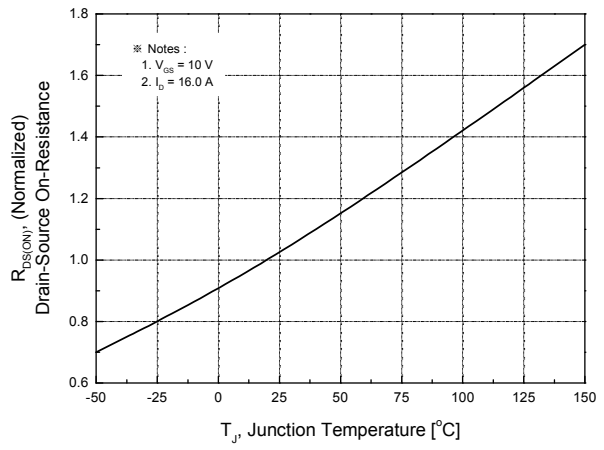

**Fig.3 On-Resistance Variation with Temperature**

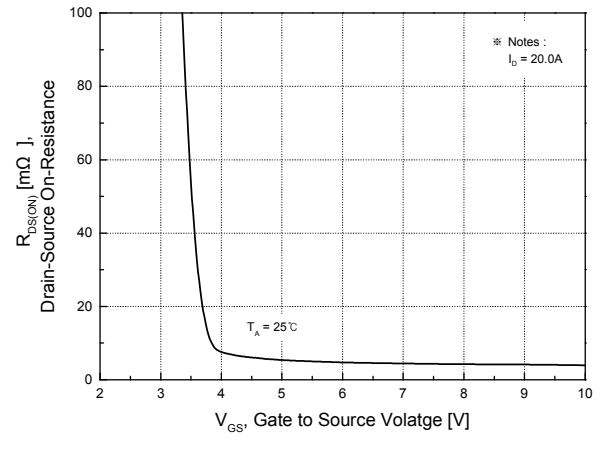

**Fig.4 On-Resistance Variation with Gate to Source Voltage**

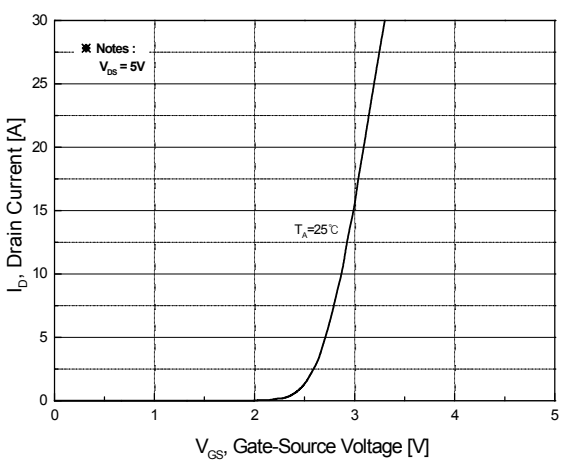

**Fig.5 Transfer Characteristics**

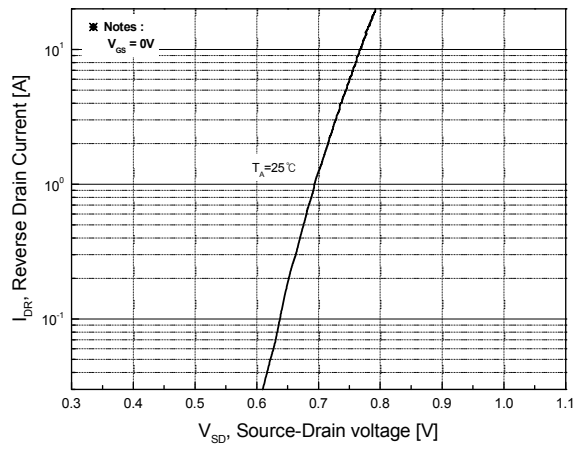

**Fig.6 Body Diode Forward Voltage Variation with Source Current and Temperature**

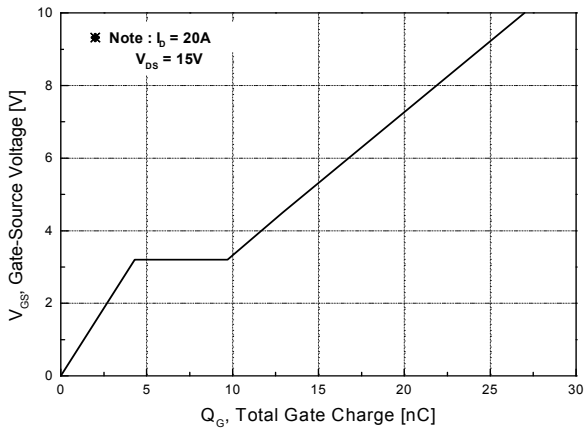

**Fig.7 Gate Charge Characteristics**

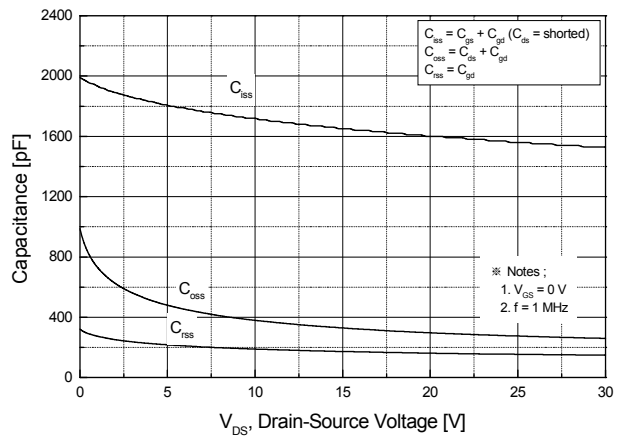

**Fig.8 Capacitance Characteristics**

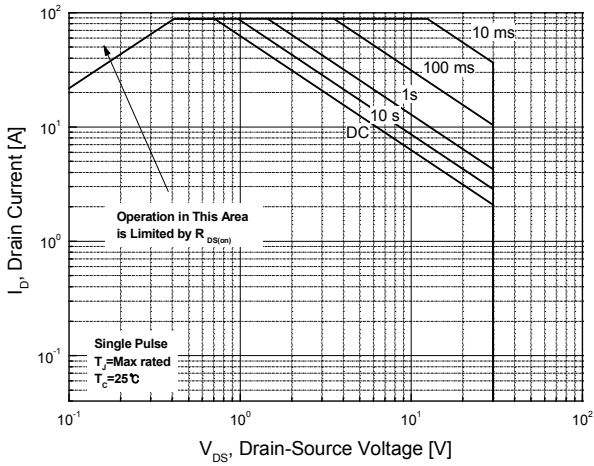

**Fig.9 Maximum Safe Operating Area**

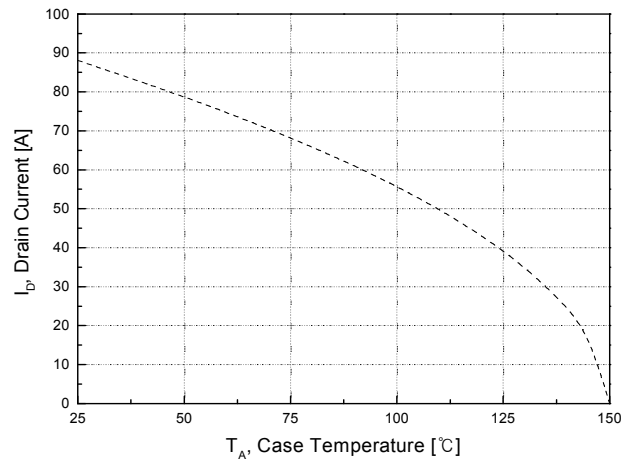

**Fig.10 Maximum Drain Current vs. Case Temperature**

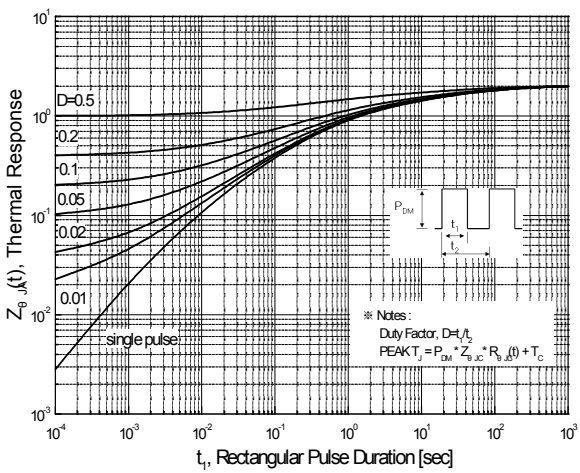
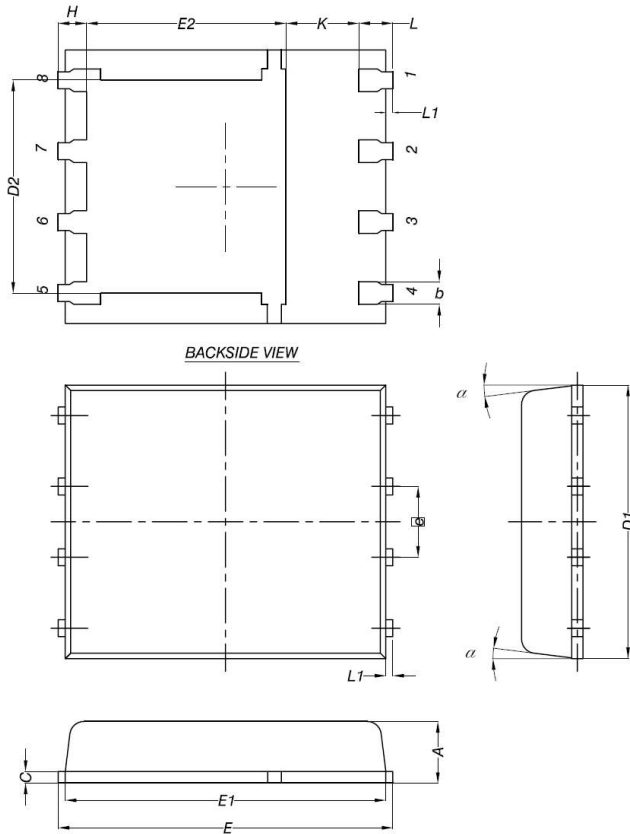

**Fig.11 Transient Thermal Response Curve**

## Package Dimension

### PowerDFN56 (5x6mm)

Dimensions are in millimeters, unless otherwise specified



Dimension	MILLIMETERS	
	Min	Max
A	0.90	1.10
b	0.33	0.51
C	0.20	0.34
D1	4.50	5.10
D2	-	4.22
E	5.90	6.30
E1	5.50	6.10
E2	-	4.30
e	1.27BSC	
H	0.41	0.71
K	0.20	-
L	0.51	0.71
$\alpha$	0°	12°

### Land Pattern

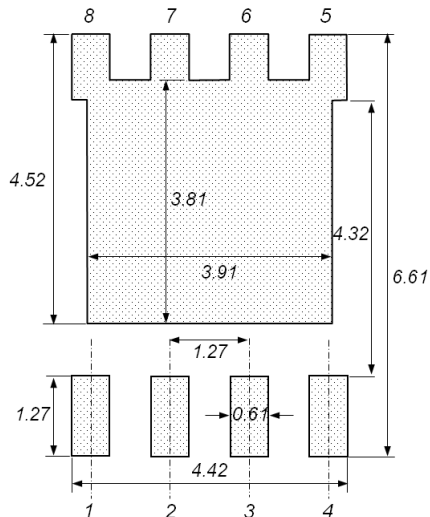

**DISCLAIMER:**

The Products are not designed for use in hostile environments, including, without limitation, aircraft, nuclear power generation, medical appliances, and devices or systems in which malfunction of any Product can reasonably be expected to result in a personal injury. Seller's customers using or selling Seller's products for use in such applications do so at their own risk and agree to fully defend and indemnify Seller.

MagnaChip reserves the right to change the specifications and circuitry without notice at any time. MagnaChip does not consider responsibility for use of any circuitry other than circuitry entirely included in a MagnaChip product. [MagnaChip](#) is a registered trademark of MagnaChip Semiconductor Ltd.